

MODULAR SYSTEM

 **Beta**
RSC 55



www.beta-tools.com

5S

is a workplace organization method of Japanese origin. The name is derived from the western transcription of 5 Japanese words: **seiri, seiton, seiso, seiketsu and shitsuke.**

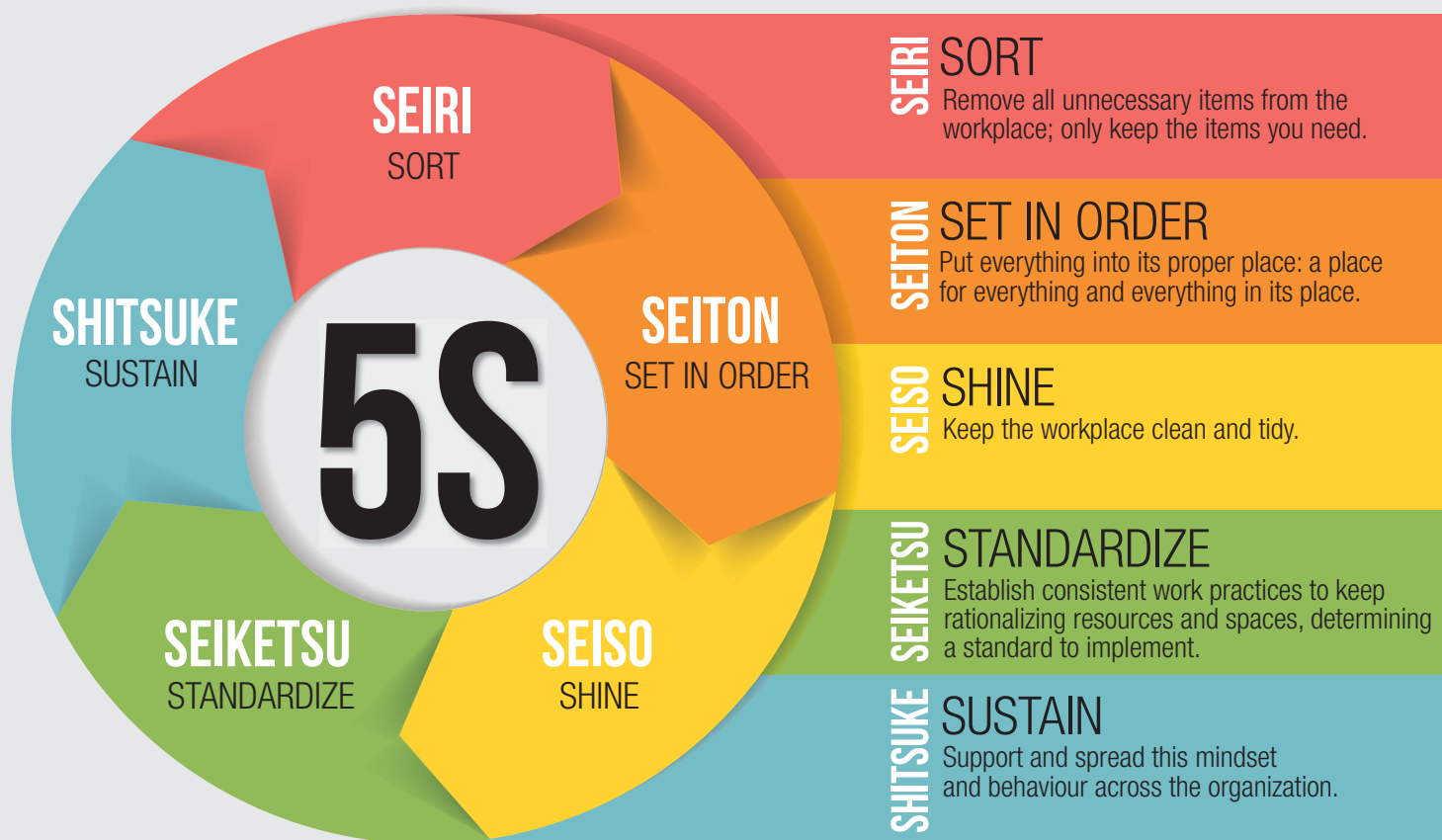

BEFORE



Following the 5 steps identified by the words allows a systematic, repeatable method to be implemented with a view to optimized working standards and enhanced operating performance.

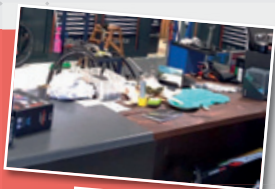

BENEFITS



Reduced time loss and improved cost-effectiveness

A proper organization and transport system for your tools will allow you to have everything you need, where you need it, and within reach.



Enhanced quality and productivity

Standard equipment does not always cater to our needs. Creating your equipment on an item-by-item basis will allow you to fully adapt it to your requirements, which will result in improved reliability and performance.



Fewer work accidents

Most accidents occur while using tools. Arranging all necessary items so that they can be easily selected for use and removing all unnecessary items will allow you to minimize misuse and reduce hazards.



Greater efficiency

Reducing the number of defects and errors will allow you to avoid delays, optimize processes and improve the company's results and efficiency.





WORKSHOP EQUIPMENT C55

The modular workshop combination that allows you to create a modern work environment customized to fit your space and storage needs. Choose from a wide range of solutions sharing high quality standards, designed to make the most of your time by optimizing work.



DESIGN

Refined finish to make your workplace a neat, aesthetically captivating environment

SPACE ORGANIZATION

A rationally organized workbench system as synonymous with optimized work



QUALITY

Beta's best "Made in Italy" quality to furnish your workshop

MADE IN ITALY



MODULARITY

Modular workshop system, customized to fit your space and storage needs

C55

055000000

Comprehensive workshop equipment combination

Comprehensive combination comprising:

- Single-door tool cabinet (C55A1)
- Two-door tool cabinet (C55A2)
- Workbench (C55B0/2)
- Workbench with sockets (C55PRO B0/2)
- Mobile roller cab with 7 drawers (C55C7)
- Fixed module with 2 storage drawers (C55M2)
- Fixed module with 7 drawers (C55M7)
- Fixed service module (C55MS)
- Tool panel with suspended cabinets (C55/2PM)
- Tool panel with shutter (C55PS-0)



Cabinets fitted with 3 interior, vertically adjustable shelves



Under-cabinet panel. Accommodates 2 power sockets (not included)



Compressed air outlet with built-in roller Ø 8 mm. Hose length: 10 m



Aluminium drawer front complete with quick release system throughout length of drawer



Aluminium shutter with lock for protecting tools

WORKSHOP EQUIPMENT COMBINATION

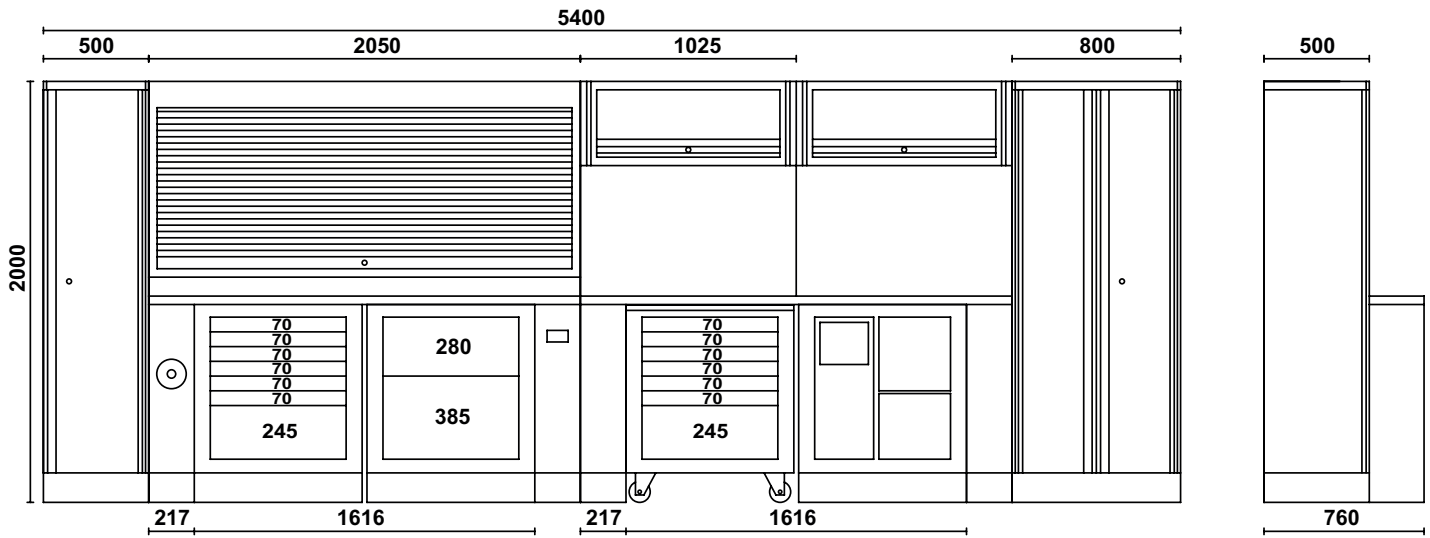

Suspended cabinets fitted with gas springs making it easier to open/close doors



Framework



Schuko socket 16+10A and EU Plug 16+10A



Drawers can accommodate thermoformed tool trays available in price list



Mobile roller cab with 2 fixed and 2 steering wheels, making it easy to pull it out



Adjustable supporting feet suitable for uneven surfaces

C55AB

055000020

Workshop equipment combination

Combination comprising:

- Two-door tool cabinet (C55A2)
- Workbench (C55B0/2)
- Fixed module with 7 drawers (C55M7)
- Fixed service module (C55MS)
- Tool panel with suspended cabinets (C55/2PM)

407 kg

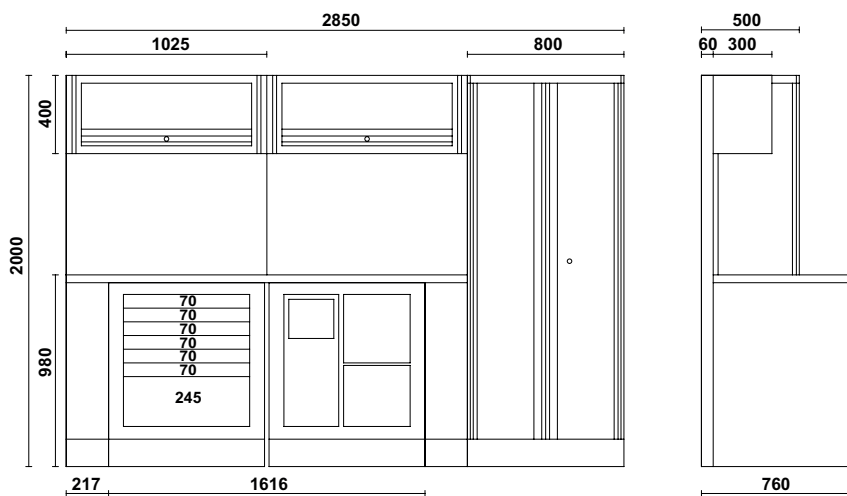

C55PB/3

055000035

Workshop equipment combination

Combination comprising:

- Workbench (C55B0/2)
- Mobile roller cab module with 8 drawers (C55C8)
- Fixed module with 2 storage drawers (C55M2)
- Wall tool system with shutter (C55PS-0)

344 kg



C55C8

C55M2

C55B0/2

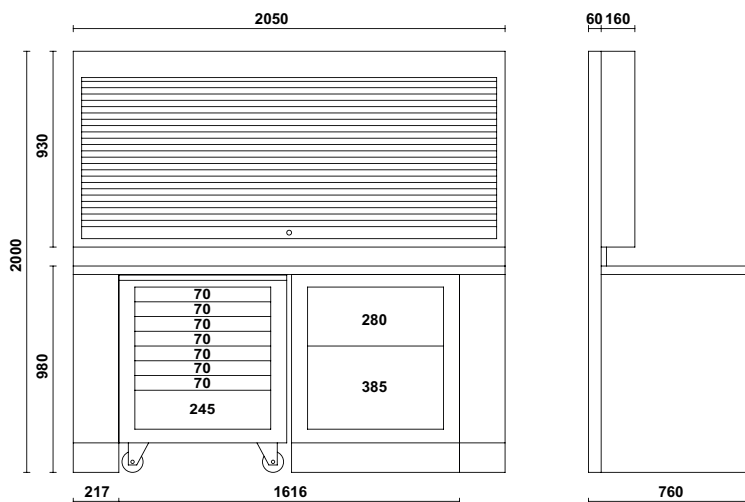

Choosing the workbench means the first step in any workshop furniture project. We at Beta offer pre-arranged solutions in versions **2, 2.8 and 4** metres in length (pages 11÷13), in grey and orange colours. However, you can configure the workbench according to your requirements, choosing the **worktop** (page 15) and the **legs** (page 14), which can be used for both sides, are fitted with vertically adjustable feet and are available in single and double versions, with power sockets and hose or cable reels.

The **modules** under the workbenches are the heart of the project: mobile or fixed, with drawers or service equipment (pages 16÷19).

The modular system also provides several different solutions for the **upper part**: plain, suspended or shuttered panels, which can accommodate power sockets (pages 20÷24).

Furthermore, a wide range of **accessories** allows you to complete the project, adapting it to your requirements (pages 26÷27).

The modular project can be extended and changed in time, as requirements and available spaces vary.

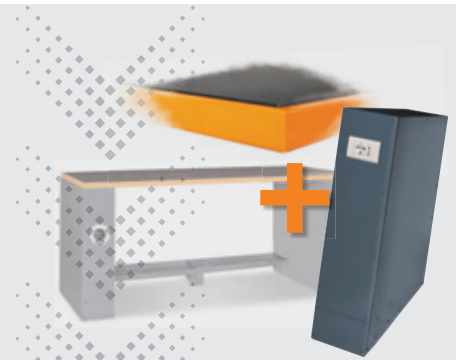

C55B/2**C55B0/2**

055000101

**C55BG/2**

055000111

Two versions differ in worktop colour

2-m-long workbench**Worktop (2050x700 mm) covered with a shockproof, non-scratch PVC coat, resistant to hydrocarbons**

- Holes for a vice (1599F/150, to be ordered separately)
- Can accommodate 2 modules under worktop
- Vertically adjustable feet

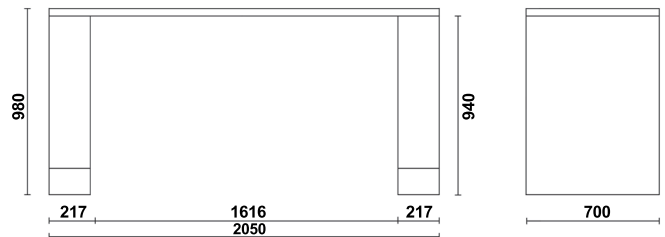
800 kg**105 kg****C55PRO B/2****C55PRO B0/2**

055000151

**C55PRO BG/2**

055000171

Two versions differ in worktop colour

2-m-long workbench**Worktop (2050x700 mm) covered with a shockproof, non-scratch PVC coat, resistant to hydrocarbons****Built-in sockets and roller:**

- Schuko socket+16+10A
- EU Plug 16+10A
- Compressed air outlet and roller, Ø 8 mm.
Hose length: 10 m
- Holes for a vice (1599F/150, to be ordered separately)
- Can accommodate 2 modules under worktop
- Vertically adjustable feet

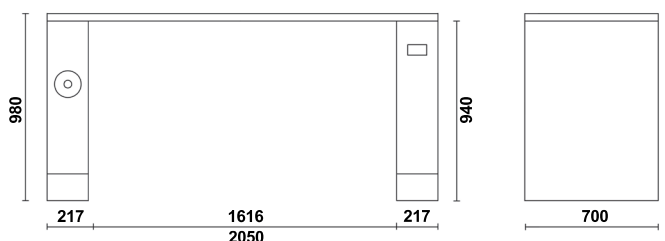
800 kg**110 kg**

C55B/2,8



C55B0/2,8

055000261



C55BG/2,8

055000281

Two versions differ in worktop colour

2.8-m-long workbench

Worktop (2850x700 mm) covered with a shockproof, non-scratch PVC coat, resistant to hydrocarbons

- Holes for a vice (1599F/150, to be ordered separately)
- Can accommodate 3 modules under worktop
- Vertically adjustable feet



129 kg

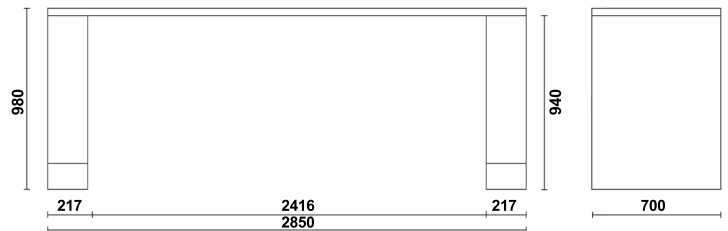

C55PRO B/2,8



C55PRO B0/2,8

055000271



C55PRO BG/2,8

055000283

Two versions differ in worktop colour

2.8-m-long workbench

Worktop (2850x700 mm) covered with a shockproof, non-scratch PVC coat, resistant to hydrocarbons

Built-in sockets and roller:

- Schuko socket+16+10A
- Plug 16+10A
- Compressed air outlet and roller Ø 8 mm. Hose length: 10 m
- Holes for a vice (1599F/150, to be ordered separately)
- Can accommodate 3 modules under worktop
- Vertically adjustable feet



134 kg

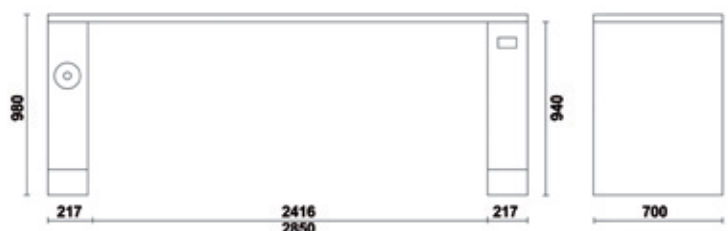

C55B/D4



C55B0/D4

055000109



C55BG/D4

055000119

Two versions differ in worktop colour

Double 4-m-long workbench with central leg

Worktop (4100x700 mm) covered with a shockproof, non-scratch PVC coat, resistant to hydrocarbons

- Holes for a vice 1599F/150 (to be ordered separately)
- Vertically adjustable feet
- Double central leg with compartment and slide-away door, 350x750 mm

1600
kg

192 kg

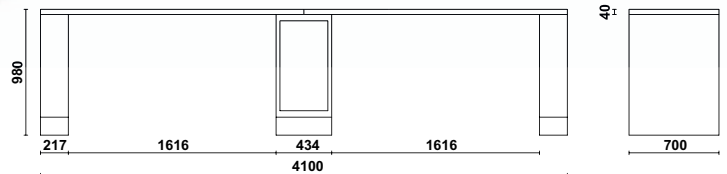
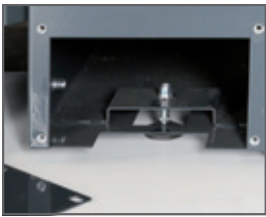

C55PRO B/D4



C55PRO B0/D4

055000159



C55PRO BG/D4

055000179

Two versions differ in worktop colour

Double 4-m-long workbench with central leg

Worktop (4100x700 mm) covered with a shockproof, non-scratch PVC coat, resistant to hydrocarbons**Built-in sockets and roller:**

- Schuko socket+16+10A
- EU Plug 16+10A
- Compressed air outlet and roller Ø 8 mm.
Hose length: 10 m
- Holes for a vice (1599F/150, to be ordered separately)
- Vertically adjustable feet
- Central double leg with slide-away door compartment, 365x750 mm

1600
kg

197 kg

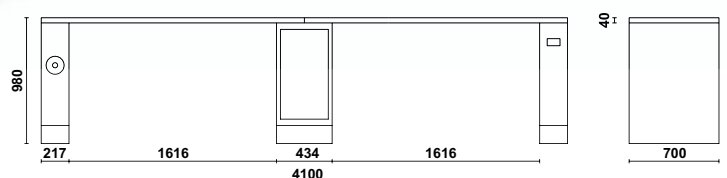

C55B/G

055000096 **New Item**

Universal leg for workbench

- With vertically adjustable feet
- Can be used for both workbench sides
- Front and side opening

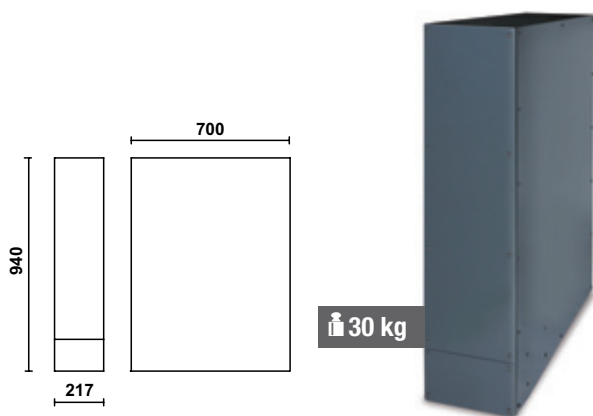

C55B/GAA

055000099 **New Item**

Universal leg for workbench with built-in hose reel

- Built-in automatic hose reel for compressed air or cold water (Ø 8 mm) item 1901BM/8
- Hose length: 10 m
- With vertically adjustable feet
- Front and side opening

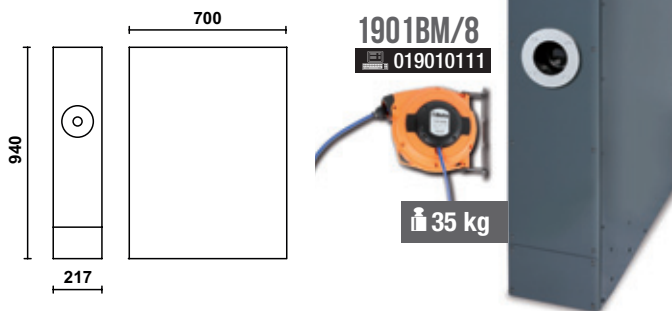

C55B/GDS

055000291

Double leg for adjoining workbenches

- Compartment with slide-away door, 365x750 mm
- With vertically adjustable feet

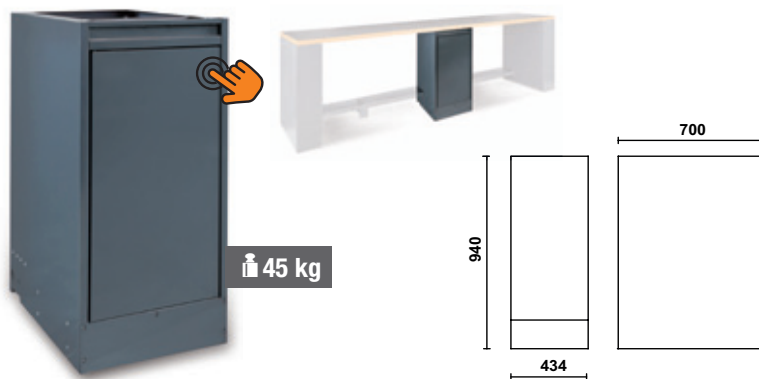

C55B/GE

055000097 **New Item**

Universal leg with power sockets for workbench

- Schuko socket+16+10A
- EU Plug 16+10A
- With vertically adjustable feet
- Front and side opening

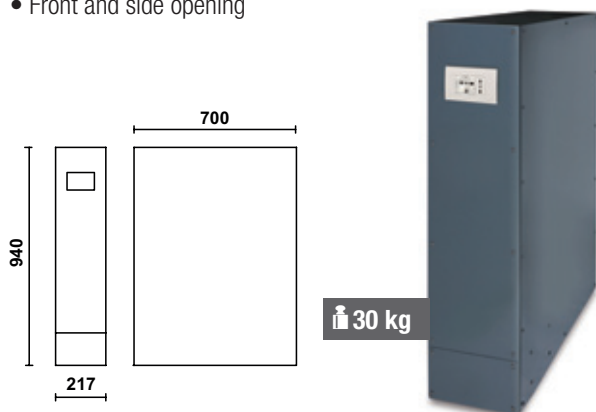

C55B/GAE

055000094 **New Item**

Universal leg with built-in electrical cable reel for workbench

- Built-in automatic cable reel with Schuko type socket item 1848.
- Cable length: 15 m
- Thermally protected
- With vertically adjustable feet
- Front and side opening

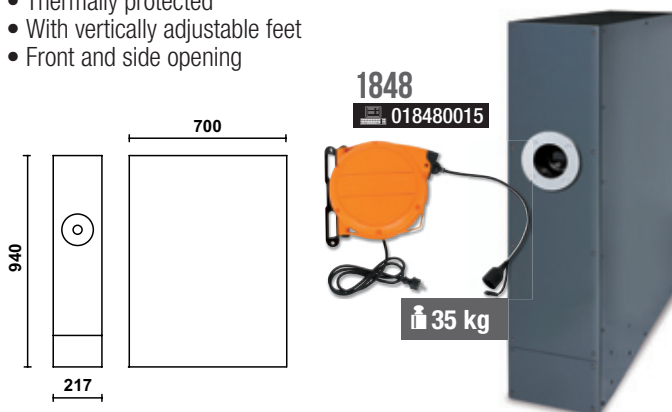

C55/PL-1,024

New Item



Two versions differ in worktop colour

1-m-long worktop for extension of workbench

Painted sheet metal worktop (1024x700 mm) covered with a shockproof, non-scratch PVC coat, resistant to hydrocarbons

pg 25



21 kg



C55B PT/2



Two versions differ in worktop colour

2-m-long worktop, for workbench

Painted sheet metal worktop (2050x700 mm) covered with a shockproof, non-scratch PVC coat, resistant to hydrocarbons
Holes for a vice (1599F/150, to be ordered separately)



43 kg



C55B PT/2,8



Two versions differ in worktop colour

2.8-m-long worktop, for workbench

Painted sheet metal worktop (2850x700 mm) covered with a shockproof, non-scratch PVC coat, resistant to hydrocarbons
Holes for a vice (1599F/150, to be ordered separately)



61 kg



C55RB

Scratch-proof PVC coat resistant to hydrocarbons

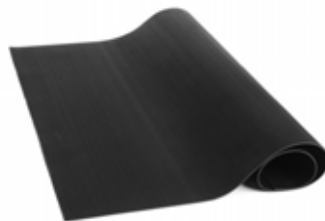

for 700x700mm long workbench

055000199 **New Item**

for 2-m-long workbench

055000195

for 1-m-long workbench

055000198 **New Item**

for 2.8-m-long workbench

055000196

C55B/VS

055000095 **New Item**

Lower workbench bracket for workshop workbenches

Dimensions: 800x230x60 mm



1599F/150

015990150

Parallel bench vice with hardened top and slides

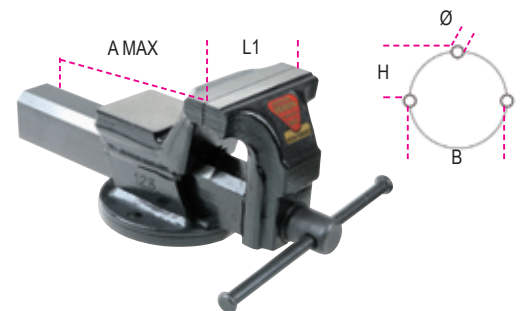

L1	BxH	Ø	A Max
150 mm	125x62 mm	13 mm	200 mm

C55T3

055000219
New Item

Trolley

- 3 tops covered in antislip ribbed rubber
- Ergonomic handle
- Two fixing options for central worktop
- Four castors Ø 100 mm:
2 fixed and 2 steering with brake
- Static load capacity: 200 kg
(distributed between 3 shelves)

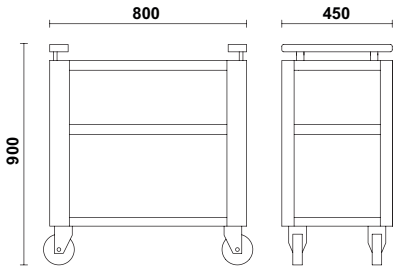

21 kg

200 kg



C55C7

055000201

Mobile roller cab with 7 drawers

- 7 drawers (588x367 mm), with ball bearing slides
- 4 castors Ø 100 mm, 2 fixed (one with brake) and 2 steering
- Aluminium opening system throughout length of drawer
- Drawer bases protected by foamed rubber mats
- Front centralized lock
- Can be fitted with foam trays

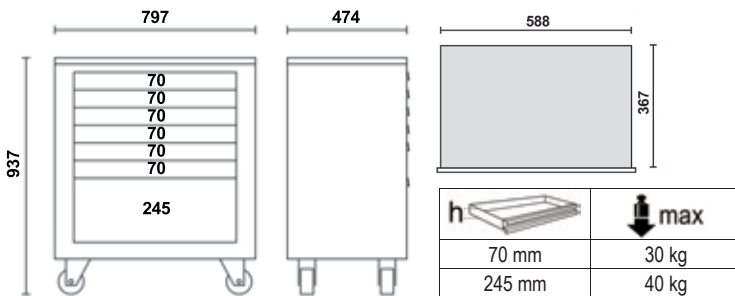

79 kg

1000 kg



C55C8

055000206

Mobile roller cab with 8 drawers

- 8 drawers (588x367 mm) with ball bearing slides
- 4 castors Ø 100 mm, 2 fixed (one with brake) and 2 steering
- Aluminium opening system throughout length of drawer
- Drawer bases protected by foamed rubber mats
- Front centralized lock
- Can be fitted with foam trays

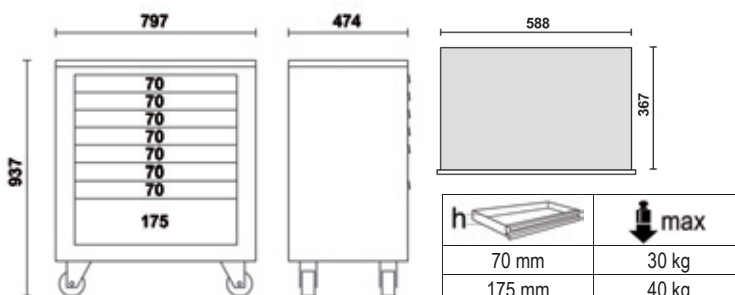

81 kg

1000 kg



C55M4 Fixed module with 4 drawers

055000212
New Item

- 4 drawers (588x367 mm) with ball bearing slides**
- Aluminium opening system throughout length of drawer
 - Drawer bases protected by foamed rubber mats
 - Front centralized lock

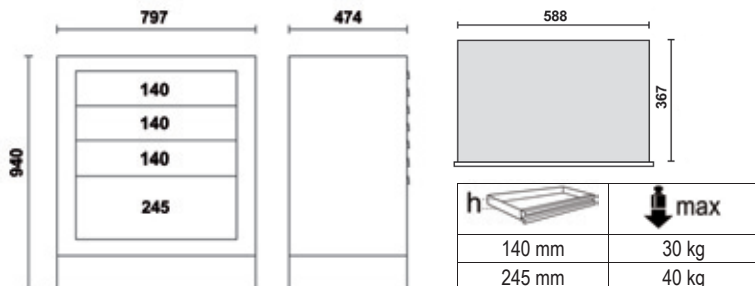

75 kg



C55M7 Fixed module with 7 drawers

055000203

- 7 drawers (588x367 mm) with ball bearing slides**
- Aluminium opening system throughout length of drawer
 - Drawer bases protected by foamed rubber mats
 - Front centralized lock
 - Can be fitted with foam trays

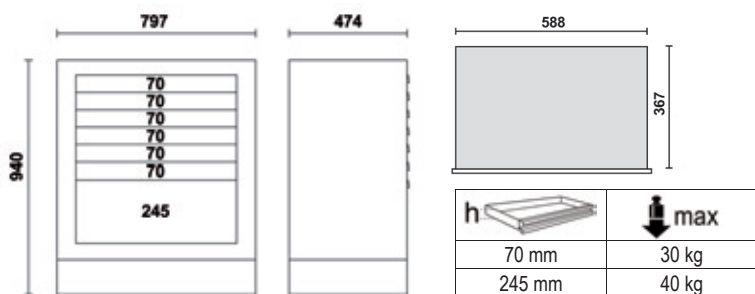

78 kg



C55M8 Fixed module with 8 drawers

055000207

- 8 cassetti da 588x367 mm, montati su guide telescopiche asfera**
- Aluminium opening system throughout length of drawer
 - Drawer bases protected by foamed rubber mats
 - Front centralized lock
 - Can be fitted with foam trays

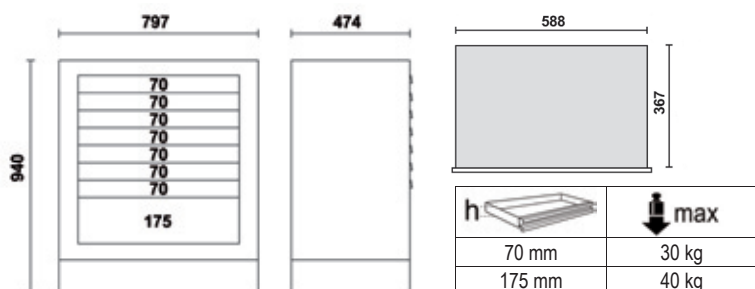

79 kg



C55M2 Fixed module with 2 drawers

055000202

- 2 drawers (588x367mm) with ball bearing slides
- Aluminium opening system throughout length of drawer
- Drawer bases protected by foamed rubber mats
- Front centralized lock

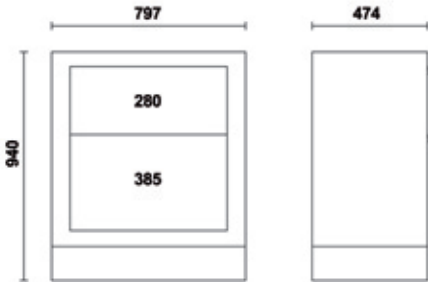

66 kg



C55MS Fixed service module

055000204

- Built-in waste bin
- Perforated paper roll compartment
- Storage drawer, 305x270 mm



75 kg



C55CS Fixed module for separate waste

055000208

- Pull-out waste compartment (588x465 mm) with ball bearing slides
- 2 capacious pull-out interior containers for sorting waste

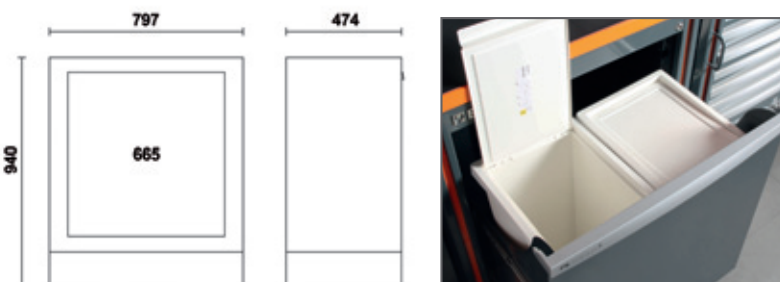

62 kg



C55MA

Fixed two-door module

055000205

- Push Pull opening
- With lock
- Interior shelf, vertically adjustable

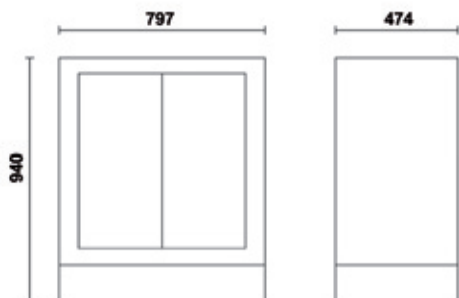

75 kg



C55MDO

Fixed oil distribution module

055000210

- 2 reels with 7m - 1/2" hose included
- Complete with 2 oil guns with digital litre counter with automatic drip catcher.
 - max. delivery rate: 0÷35 l/min
 - viscosity: 8÷5000 mPas

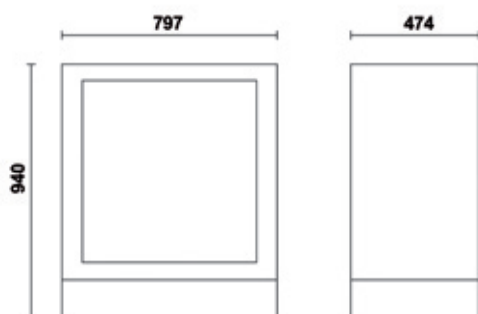

94 kg





C55PFA-1,0

C55PFA-1,0

055000316 *New Item*

Self-supporting perforated panel, 1-m-long

Perforated steel tool panel (1024x25x1000 mm)



C55PM

C55PT1,0X0,6

C55PM

055000302 *New Item*

Suspended cabinet, 1-m-long

Dimensions: 1024x400x300 mm; fitted with gas springs, making it easier to open and close door

C55PT1,0X0,6

055000314 *New Item*

Under-cabinet panel, 1-m-long

Dimensions: 1024x25x620 mm



C55PM

C55PTE-1,0

C55PM

055000302 *New Item*

Suspended cabinet, 1-m-long

Dimensions: 1024x400x300 mm; fitted with gas springs, making it easier to open and close door

C55PTE-1,0

055000319 *New Item*

Under-cabinet panel, 1-m-long

Dimensions: 1024x25x620 mm

Accommodates 2 power sockets (not included)



C55PM

C55PT1,0X0,6

C55/PF

C55PM

055000302 *New Item*

Suspended cabinet, 1-m-long

Dimensions: 1024x400x300 mm; fitted with gas springs, making it easier to open and close door

C55PT1,0X0,6

055000314 *New Item*

Under-cabinet panel, 1-m-long

Dimensions: 1024x25x620 mm

C55/PF

055000307 *New Item*

Perforated under-cabinet panel, 1-m-long

Perforated tool panel (1024x620 mm) designed to match C55PT 1,0X0,6

C55P/MCD

055000257 *New Item*

Double central intermediate uprights



2000



C55/2PM

055000301

Tool wall system with 2 suspended cabinets

- 2 suspended cabinets, 1024x400x300 mm, fitted with gas springs, making it easier to open and close doors
- 2 wall panels, 1024x620 mm; can accommodate perforated tool panels C55/2PF (to be ordered separately)
- Supplied with framework
- Matches 2-m-long workbench



80 kg

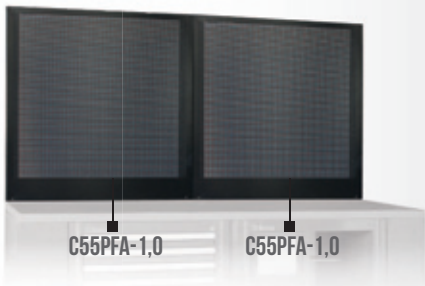
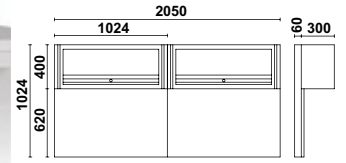

C55PFA-1,0

055000316 **New Item**

Self-supporting perforated panel, 1-m-long

Perforated steel tool panel (1024x25x1000 mm)

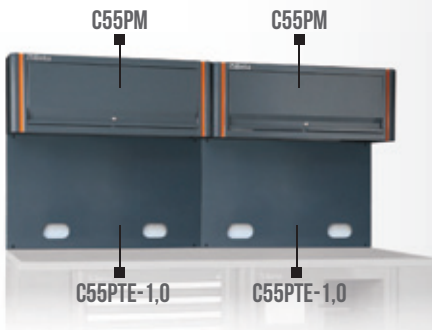

C55PM

055000302 **New Item**

Suspended cabinet, 1-m-long

Dimensions: 1024x400x300 mm; fitted with gas springs, making it easier to open and close door

C55PTE-1,0

055000319 **New Item**

Under-cabinet panel, 1-m-long

Dimensions: 1024x25x620 mm

Accommodates 2 power sockets (not included)

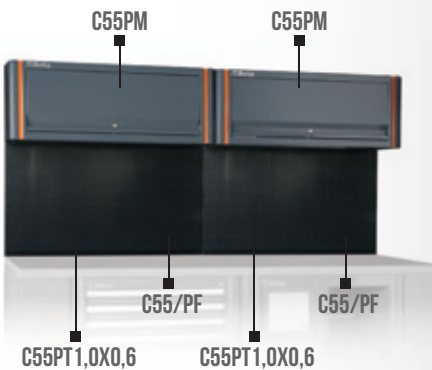

C55PM

055000302 **New Item**

Suspended cabinet, 1-m-long

Dimensions: 1024x400x300 mm; fitted with gas springs, making it easier to open and close door

C55PT1,0X0,6

055000314 **New Item**

Under-cabinet panel, 1-m-long

Dimensions: 1024x25x620 mm

C55/PF

055000307 **New Item**

Perforated under-cabinet panel, 1-m-long

Perforated tool panel (1024x620 mm) designed to match C55PT 1,0X0,6



C55P/2MDX-SX

055000253 **New Item**

Right/left wall uprights, pair



C55P/MCD

055000257 **New Item**

Double central intermediate uprights



C55PS



C55PS-0
055000250



C55PS-G
055000255

Light grey shutter



Tool wall system with shutter

- Aluminium shutter, vertically adjustable, with lock
- Removable perforated tool panel
- Supplied with framework
- 50-hook GPS kit included
- Matches 2-m-long workbench

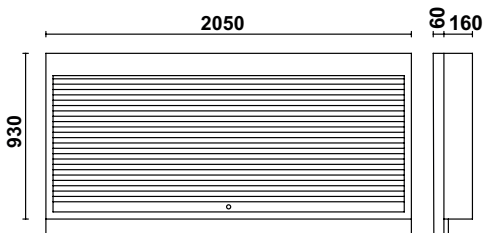

88 kg



C55PSE

New Item



C55PSE-0
055000258

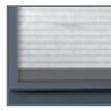

C55PSE-G
055000260

Light grey shutter

Tool wall system with shutter accommodating 2 power sockets

- Aluminium shutter, vertically adjustable, with lock
- Removable perforated tool panel
- Supplied with framework
- 50-hook GPS kit included
- Accommodates power sockets (not included)
- Matches 2-m-long workbench

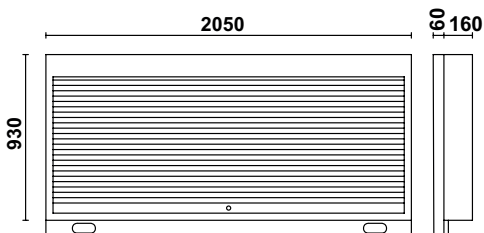

88 kg



5958U

059580028

Assortment of 85 tools for universal use



Quantity/Description

Quantity/Description	Beta N.
17 combination wrenches 6÷22 mm	42
12 offset hexagon key wrenches O 2÷10 mm	96N/SC12
13 1/2" square drive hexagon sockets with rail O 10÷22 mm	920A/SB13
8 1/2" square drive hexagon sockets with rail O 23÷32 mm	920A/SB8
1 1/2" drive extension bar 125 mm	920/21
1 1/2" drive extension bar 255 mm	920/22
1 1/2" drive universal joint	920/25
1 1/2" drive sliding T-handle	920/42
1 1/2" drive reversible ratchet R	920/55
1 circlip pliers straight, internal O 180 mm	1032
1 circlip pliers straight, external \bullet 175 mm	1036
1 slip joint pliers boxed joints 250 mm	1048
1 self - locking pliers 240 mm	1052
1 heavy duty diagonal cutting nippers Z 160 mm	1084BM
1 electrician's scissors, straight blades	1128BMX
1 half-round needle nose pliers = 180 mm	1150BM
1 extra long needle knurled nose pliers, bi-material handles \bullet 160 mm	1166BM
7 screwdrivers for cross head Phillips® screws \bullet 3x75 - 3,5x100 - 4x125 5,5x150 - 6,5x150 - 8x200 - 10x200 mm	1260
4 screwdrivers for cross head Phillips® screws \oplus PH0x60 - PH1x80 PH2x100 - PH3x150 mm	1262/S4
1 engineer's hammer 300 g	1370
1 soft face hammer O 35 mm	1390
1 measuring tape 5 m	1692
5 second cut files 200 mm	1719BMA/S5
1 hacksaw frame, aluminium handle	1725
1 plastic oil can 150 cc	1754
1 snap - off blade utility knife	1771

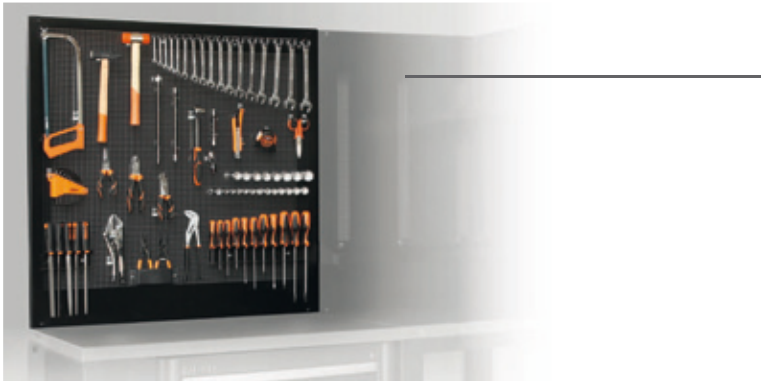

5957U-P

059570040

Assortment of 133 tools for universal use



Quantity/Description

Quantity/Description	Beta N.
6 pin punches 2-3-4-5-6-8 mm	31
6 2 drift punches, 1 centre punch, 3 flat chisels with metal holder	38
17 combination wrenches 6÷22 - 24 - 27 - 30 - 32 mm	42/S17X
12 double open end wrenches 6x7 ÷ 30x32 mm	55/S12X
8 offset hexagon key wrenches 2 ÷ 10 mm	96T/S8
8 offset key wrenches, for Torx® head screws O T9 ÷ T40	97TX/SC8
1 adjustable wrench 250 mm	111
13 1/2" square drive bi-hex sockets with rail	920A/SB13
8 1/2" square drive bi-hex sockets with rail	920A/SB8
4 1/2" socket drivers for slotted head screws \bullet 1,2x65-1,2x8-1,6x9-2x12 mm	920LP
3 1/2" socket drivers for Phillips® screws \oplus PH1-PH2-PH3	920PH
1 1/2" drive extension bar 125 mm	920/21
1 1/2" drive extension bar 250 mm	920/22
1 1/2" drive universal joint	920/25
1 1/2" drive sliding T-handle	920/42
1 1/2" drive reversible ratchet R	920/55
1 pry bar	963
1 circlip pliers straight, internal O 180 mm	1032
1 circlip pliers bent, internal O 170 mm	1034
1 circlip pliers straight, external \bullet 175 mm	1036
1 circlip pliers bent, external \bullet 175 mm	1038
1 Slip joint pliers boxed joints 250 mm	1048
1 self - locking pliers 240 mm	1052
1 diagonal cutting nippers Z 160 mm	1082BM
1 heavy duty diagonal cutting nippers Z 160 mm	1084BM
1 toggle lever assisted end cutting nippers Z 180 mm	1092V
1 tin snips 250 mm	1112
1 electrician's scissors, straight blades	1128BMX
1 half-round needle nose pliers = 180 mm	1150BM
1 extra long needle knurled nose pliers, bi-material handles \bullet 160 mm	1166BM
1 bent needle nose pliers \bullet 160 mm	1168BM
7 screwdrivers for cross head Phillips® screws \bullet 2,5x75 - 3x75 - 4x125 - 5,5x100 - 6,5x150 - 8x200 - 10x200 mm	1260
4 screwdrivers for cross head Phillips® screws \oplus PH0x60 - PH1x80 - PH2x100 - PH3x150 mm	1262
2 engineer's hammer 300 - 600 g	1370
1 soft face hammer 35	1390
1 sliding gauge	1650
1 measuring tape 5 m	1692/5
1 flexible magnetic pick-up tool	1712E/2
1 two cutting edges scraper 200 mm	1717A
1 three - cutting edges scraper 200 mm	1717B
5 second cut files 200 mm	1719BMA/S5
1 hacksaw frame, aluminium handle 420 mm	1725
1 metal oil can	1751
1 snap - off blade utility knife	1771BM

Solutions

2m + 0,80



C55PFA-0,8

055000315 **New Item**

Self-supporting perforated panel, 0.8-m-long

Perforated steel tool panel (800x25x1000 mm)

C55PFA-0,8



C55PM/M0,8

C55PM/M0,8

055000312 **New Item**

Suspended cabinet, 0.8-m-long

Dimensions: 800x620 mm; fitted with gas springs making it easier to open and close door

C55PTE-0,8

055000318 **New Item**

Under-cabinet panel, 0.8-m-long

Dimensions: 800x620 mm

Accommodates 1 power socket (not included)

C55PTE-0,8

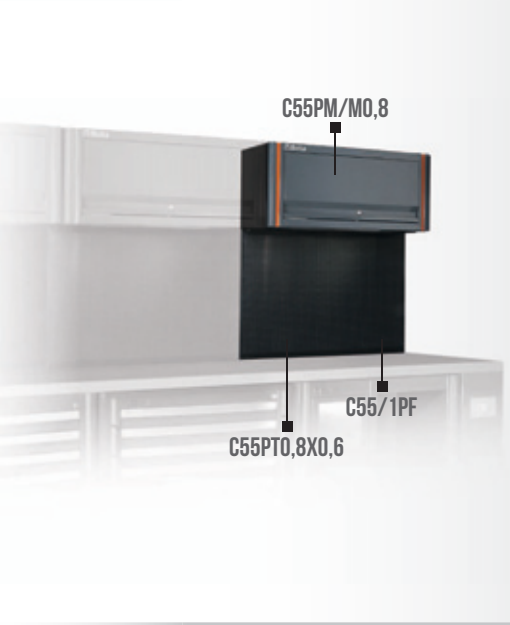

C55PM/M0,8

C55PM/M0,8

055000312 **New Item**

Suspended cabinet, 0.8-m-long

Dimensions: 800x620 mm; fitted with gas springs making it easier to open and close door

C55PT0,8X0,6

055000313 **New Item**

Under-cabinet panel, 0.8-m-long

Dimensions: 800x25x620 mm

C55/1PF

055000309

Perforated under-cabinet panel, 0.8-m-long

Perforated tool panel (800x620 mm)

C55PT0,8X0,6

C55/1PF



C55P/MCD

055000257 **New Item**

Double central intermediate uprights



2000

C55AC

055000360 **New Item**

Self-supporting complete corner

- Worktop (700x700 mm) with legs
- 2 upper tool wall systems complete with 2 fixing shelves (670x160 mm)



C55KAI

055000365 **New Item**

Corner worktop, 700x700 mm combination with legs

Painted sheet metal worktop (700x700 mm) covered with a shockproof, non-scratch PVC coat, resistant to hydrocarbons



C55B/1

New Item



C55B0/1

055000090



C55B6/1

055000091

Two versions differ in worktop colour

Extension workbench, 1-m-long

Worktop (1024x700 mm) covered with a shockproof, non-scratch PVC coat, resistant to hydrocarbons

- Universal leg with vertically adjustable feet
- 1 fixed module: 7 drawers (588x367 mm) with ball bearing slides



To be used with corner worktop C55KAI

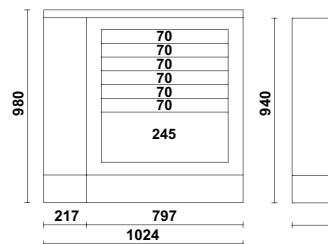

C55KAS

055000370 **New Item**

Upper corner with tool wall systems

- 2 perforated tool wall systems (700x1000 mm)
- 2 fixing shelves (670x160 mm)"



C55MP

055000374 **New Item**

Steel shelves for corner elements



C55A1

055000411

Sheet metal single-door tool cabinet

- 3 removable, vertically adjustable shelves
- With lock
- Usable interior dimensions: 1770x420x420 mm

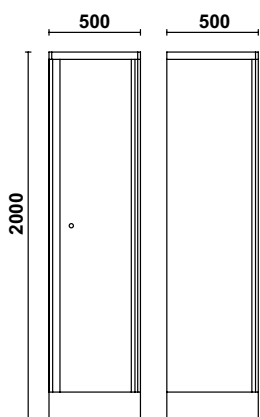

50 kg

C55A2

055000412

Sheet metal two-door tool cabinet

- 3 removable, vertically adjustable shelves
- With lock
- Usable interior dimensions: 1770x700x420 mm

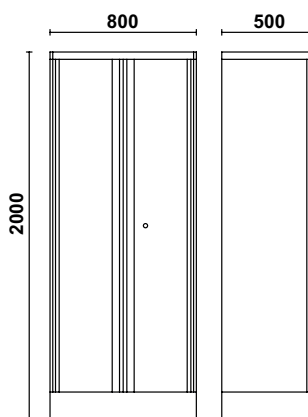

72 kg

C55A1/R42

055000461

Interior shelf for tool cabinet C55A1



400x400 mm

C55A2/R70

055000462

Interior shelf for tool cabinet C55A2



700x400 mm

C55LMP/1

055000320

LED lamp

- Length: 1 m
- Easy to fix under wall cabinet through a pair of magnets
- ON/OFF switch
- Built-in cable and transformer, 25 W
- 1300 lumens



1,2 kg

1000 mm

C55LMP/2

055000322

2 LED lamps

- length: 2 1-m-long lamps, connected to each other
- Easy to fix under cabinet through a pair of magnets
- ON/OFF switch
- Built-in cable and transformer, 18 W
- 1300 lumens



2 kg

CP

088880470 **New Item**

Wall-mounted bottle holder rack, made of steel

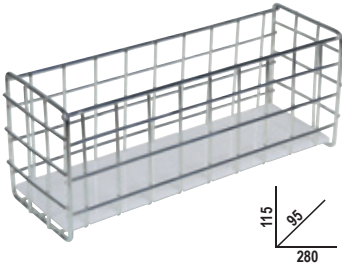

PM/6C

088880440 **New Item**

6-tray tool holder, made of plastic, with support

- Interior dimensions of tray: 80x60 mm

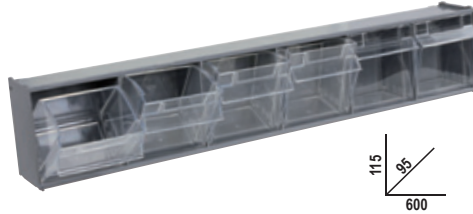

PM/5C

088880450 **New Item**

5-tray tool holder, made of plastic, with support

- Interior dimensions of tray: 95x120 mm

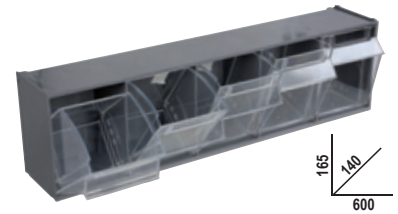

KIT/GPS

088880119

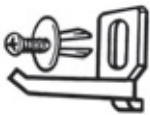

GM



	Ø
088880250	6,5
088880251	9,5
088880252	13
088880253	16
088880254	19
088880255	25

S55/8

088880420

55/S8
55AS/8
55MP/S8

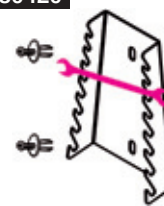

S55/12

088880421

55/S12
55/S12X
55AS/12
55MP/S12

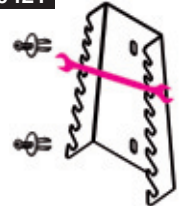

ST2P

088880422

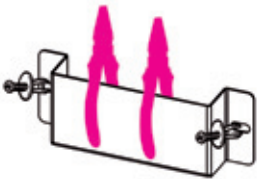

TSP

088880402

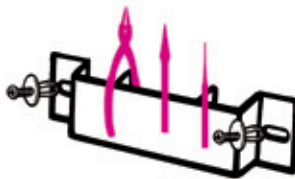

S952/10

088880423

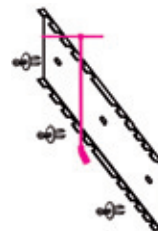

S1719BM

088880404

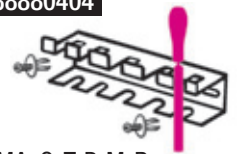

1719BMA: Q-T-P-M-R
1719BMD: Q-T-P-M-R

SGN

088880405



1290N-1292N-1299N/PZ
1260N-1262N-1269N/PZ
1201N-1202N-1209N/PZ

S42/17

088880428

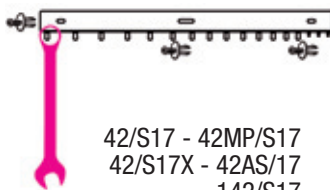

42/S17 - 42MP/S17
42/S17X - 42AS/17
142/S17

S951/6

088880429

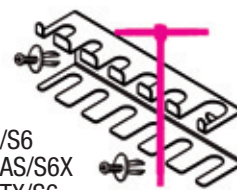

951/S6
951AS/S6X
951TX/S6

SPG11

088880910

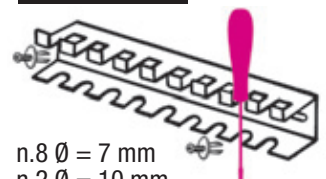

n.8 Ø = 7 mm
n.2 Ø = 10 mm
n.1 Ø = 12 mm

S1203/8

088880430

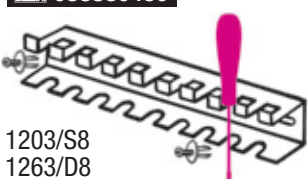

1203/S8
1263/D8
1293/S8

S96T/8

088880431

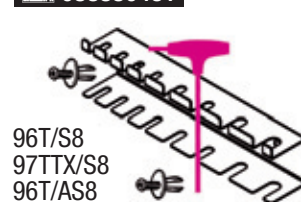

96T/S8
97TTX/S8
96T/AS8

96T/SPV

000960958

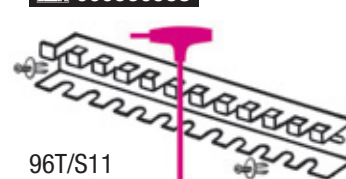

96T/S11
97TTX/S11



RSC55 allows you to order the benches and tool wall system with shutter in a neutral (grey) version and customize the vertical coloured inserts by choosing from 7 different adhesive tapes.



1. Order your modules in a neutral colour

2. Order the vertical insert

Now choose the colour to your taste or according to your company's colours.

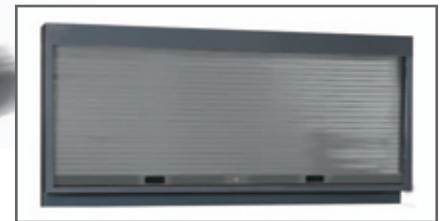

C55STR

Adhesive tape

25 m

allows to tailor the vertical tapes of garage furniture item C55



2011			055000901
9006			055000902
3000			055000903
5015			055000904
1023			055000905
6029			055000906
9016			055000907
1035			055000909



IMAGINE AND CREATE...

Configure your workshop
in 3D online

www.rsc55.com

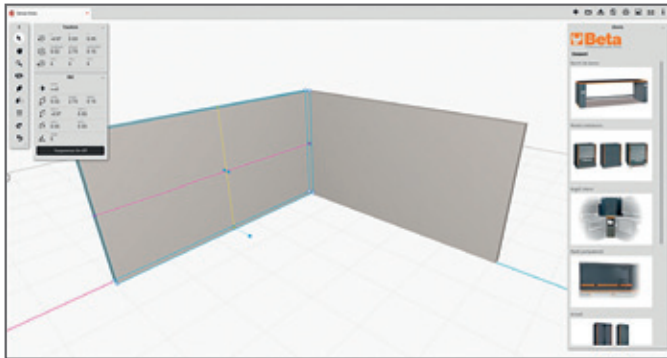

STEP 1

Draw the walls

Create the walls according to the dimensions of your workshop.

STEP 2

Design your workbench system

Select and assemble the component parts, to make your own combination.

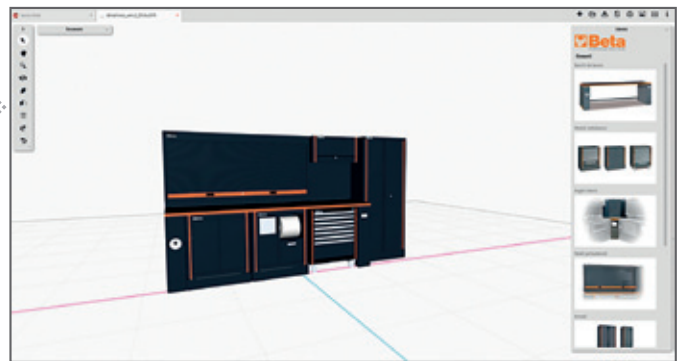

STEP 3

View the result in 3D

The combination is immediately displayed in 3D and can be viewed from different angles.

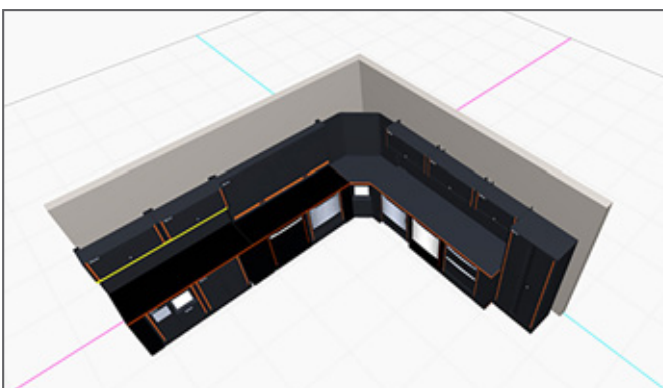

STEP 4

Request a quote

Print the detail of the arrangement in PDF format and take it to your dealer to get a quote.



CUSTOMIZED MODULES ON REQUEST

Fill your drawers with customized modules in six steps

1 Determine your needs and send your project to the Beta dealer



2 We will receive and codify your initial assortment of the project

Image	Product	Code Beta
	Self-locking pliers	010540022
	Pliers	010440250
	Pliers	011500006
	Screwdrivers for slotted head screws	012010039
	Screwdrivers for cross head Phillips® screws	012020018

3 We will execute the design

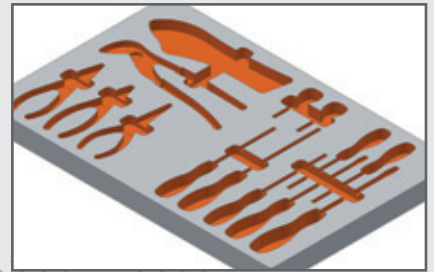

4 We will submit the final layout for your approval

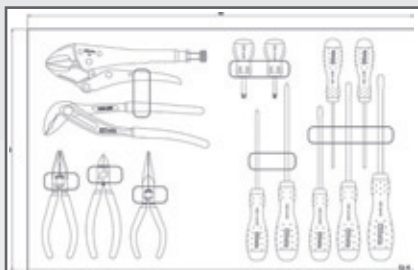

5 We will build the soft modules in Beta's factory in Sovico



6 We will deliver the tools in the customized modules



Contact our dealers
www.beta-tools.com/en/find-a-dealer/



998011062

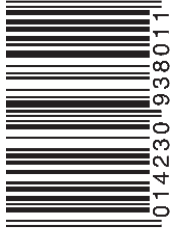

8 014230 938011

QUALITY ORGANIZATION
DESIGN
MODULARITY



ORGANIZATION
QUALITY
MODULARITY



MODULARITY ORGANIZATION
QUALITY
DESIGN
ORGANIZATION