



 **Beta**

*Special*  
MOTORBIKE  
CATALOGUE



**2020**  
[www.beta-tools.com](http://www.beta-tools.com)

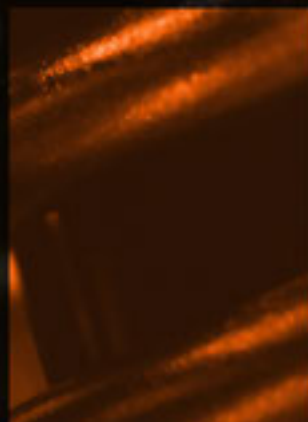
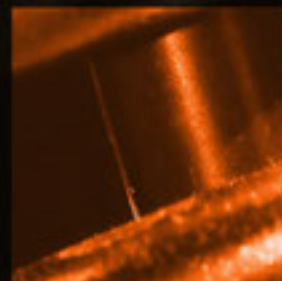
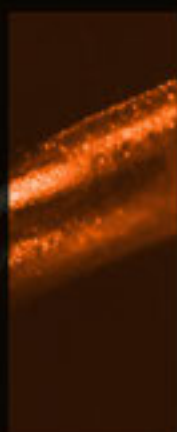



Beta Utensili leads the way in the production of professional hand tools. Beta's products are synonymous with unparalleled quality and reliability, as the result of eighty years of experience and tradition. Our products are regularly updated, their quality being highly appreciated by the engineers and mechanics of the best racing teams in the Road Racing World Championship Grand Prix, Superbike World Championship, Motocross World Championship and World Enduro Championship.

# 2020

The special Motorbike Catalogue is an accurate selection of products specially designed for the motorcycle industry. General maintenance and controlled tightening tools, stands and jacks as well as several motorcycle items are available, the emphasis being on technical details. A useful abstract from a product range which exceeds 14,000 coded items, a must-have instrument for identifying the products that best satisfy the most demanding professionals' requirements.

50 Years in Motorsports





Technical  
Partner

# INDEX



4÷17  
CONTAINERS AND ASSORTMENTS



18÷33  
GENERAL TOOLS



34-35  
CONTROLLED TIGHTENING



36-37  
DIAGNOSTICS



38÷40  
ENGINE



40÷42  
OIL AND FILTERS



42-43  
ELECTRIC SYSTEM



44-45  
TRASMISSION - BRAKES  
- SUSPENSIONS



46÷49  
WHEELS



50÷55  
STANDS AND JACKS



56-57  
SPECIALIZED EQUIPEMENT



58÷60  
TIE DOWN SYSTEMS



# Portable tool chest

## C22S

### Portable tool chest with three drawers

- Three drawers (588x277 mm) with ball bearing slides:
  - 1 drawer, 50 mm high
  - 2 drawers, 70 mm high.
- Front centralized safety lock.
- Retractable side handles for ease of handling.



h	max
50 mm	25 kg
70 mm	25 kg

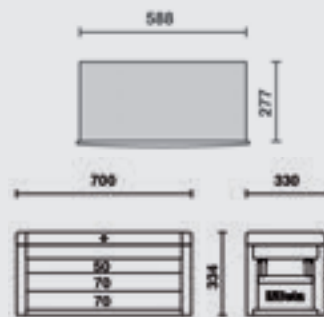

	C22S-O	19 kg	022000501
	C22S-G	19 kg	022000502
	C22S-R	19 kg	022000503

## C23S

### Portable tool chest with five drawers

- Five drawers (588x277 mm) with ball bearing slides:
  - 2 drawers, 50 mm high
  - 3 drawers, 70 mm high.
- Front centralized safety lock.
- Retractable side handles for ease of handling.



h	max
50 mm	25 kg
70 mm	25 kg

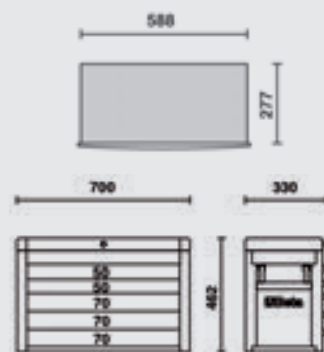

	C23S-O	26 kg	023000501
	C23S-G	26 kg	023000502
	C23S-R	26 kg	023000503

## COVER C22S

### Nylon cover for portable chest item C22S



2200-COVER C22S 022000910

## COVER C23S

### Nylon cover for portable tool chest item C23S



2300-COVER C23S 023000920

## C23SC

### Portable tool chest with eight drawers

- Eight drawers with ball bearing slides:
  - 4 drawers, 50 mm high
  - 3 drawers, 70 mm high
  - 1 drawer, 100 mm high.
- Front centralized safety lock.
- Retractable side handles for ease of transport.



h	max
50 mm	25 kg
70 mm	25 kg

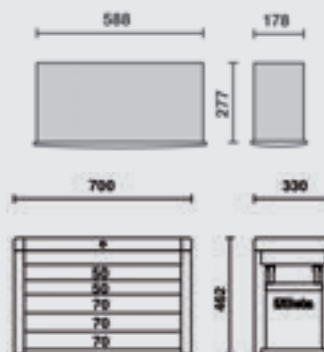

	C23SC-O	28 kg	023000511
	C23SC-G	28 kg	023000512
	C23SC-R	28 kg	023000513

# Mobile roller cab



- Drawer bases protected by foamed rubber mats.
- Four castors 125 mm in Ø: 2 fixed and 2 steering (one with brake).
  - Front centralized safety lock.
  - Static load capacity: 800 kg.
- Thermoplastic worktop designed to match tool chests C22S, C23S, C23SC and C23ST
  - Integrated side bottle holder.
- Paper roll holder item 2400S-R/PC can also be included.

## C24S/5

### Mobile roller cab with five drawers

- Five drawers (588x367 mm) with ball bearing slides:
  - 2 drawers, 70 mm high
  - 2 drawers, 140 mm high
  - 1 drawer, 280 mm high



h	max
70 mm	25 kg
140 mm	30 kg
280 mm	35 kg

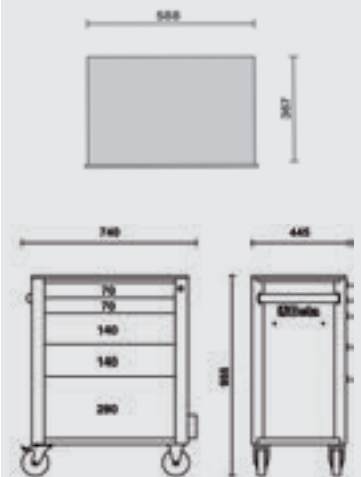

	C24S/5-O	52 kg	024002051
	C24S/5-G	52 kg	024002052
	C24S/5-R	52 kg	024002053

## C24S/7

### Mobile roller cab with seven drawers

- Seven drawers (588x367 mm) with ball bearing slides:
  - 5 drawers, 70 mm high
  - 1 drawer, 140 mm high
  - 1 drawer, 210 mm high



h	max
70 mm	25 kg
140 mm	30 kg
210 mm	30 kg

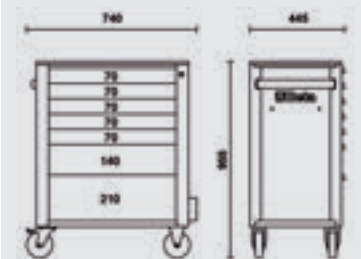

	C24S/7-O	58 kg	024002071
	C24S/7-G	58 kg	024002072
	C24S/7-R	58 kg	024002073

## COVER C24S

### Nylon cover for mobile roller cabs items C24S



2400-COVER C24S 024000910

# Tool trolley

## C41H

### Two-module tool trolley

- Sheet metal frame and plastic tops, synonymous with remarkable sturdiness and reduced weight.
- 2 detachable modules: 1 upper tool box, 1 module with 2 drawers 95 mm in height, 1 pull-out case made of plastic, 66 mm high, and 1 drawer 295 mm in height.
- Oversized castors (160 mm), built into frame for easy transport - for example, on steps.
- Side centralized lock for closing drawers of lower module.
- Drawers with ball bearing slides and double closing hook.
- Telescopic aluminium handle.
- Small tool holder built into upper tool box.
- Lower drawer with double ballbearing slide

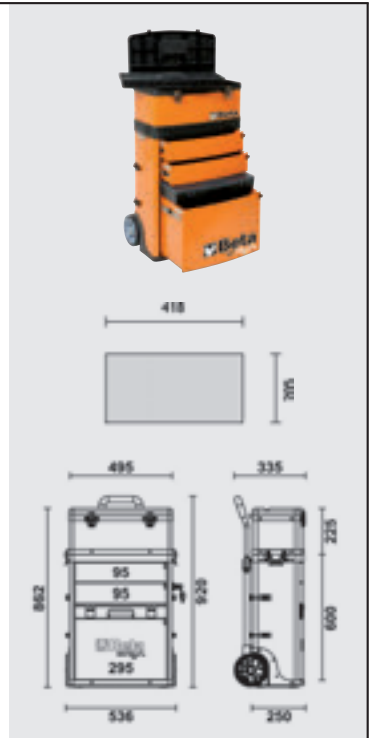

C41H 21 kg 041000002

## COVER C41H

### Nylon cover for tool trolley item C41H



\* Colours available on request

4100-COVER C41H 041000930

## C43

### Three-module tool trolley

- Sheet metal frames and plastic tops
- 3 detachable modules:
  - 1 upper tool box, 222 mm high
  - 1 central module, 168 mm high with 2 drawers 60 mm high
  - 1 lower module, 332 mm high, with up-and-over door, 280 mm high, with castors
- Castors  $\varnothing$  128 mm
- Telescopic handle, can be adjusted in 4 positions
- Module release system with access to all tool compartments
- Upper tool box with removable interior object compartment and 2 tote-trays built into cover

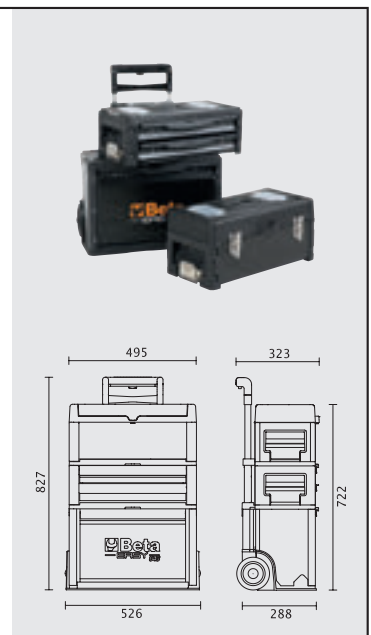

C43 15,5 kg 043000003

## C27S

### Folding tool trolley for outdoor jobs, empty

- Folding tool trolley. Its unique patented design guarantees an effortless transport.
- 2 drawers, 588x277 mm, with ball bearing slides for two-way opening.
- Large lower object compartment, 588x277x220 mm.
- Sheet metal frame.
- 2 fixed castors, Ø 160 mm, and 2 steering castors with brake, Ø 100 mm
- Thermoplastic worktop with 6 built-in tool trays.
- Centralized lock.
- Can accommodate drawer partitions and MC foam tool trays



h	max
70 mm	20 kg

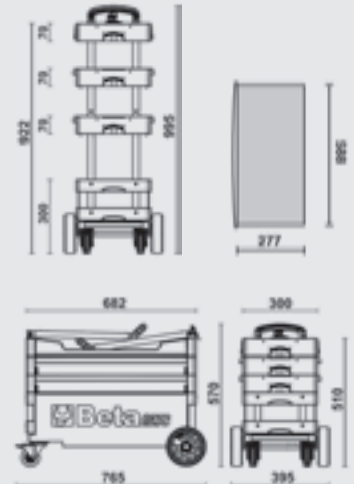

	C27S-O 20 kg 027000201	
	C27S-G 20 kg 027000202	
	C27S-R 20 kg 027000203	

## C51

### Trolley

- 3 tops covered in antislip ribbed rubber
- Ergonomic handle
- Two fixing options for central worktop
- Four castors Ø 100 mm:  
2 fixed and 2 steering (1 with brake)
- Static load capacity: 200 kg  
(distributed between 3 shelves)



	C51-O 21 kg 051000001	
	C51-G 21 kg 051000002	
	C51-R 21 kg 051000003	

## C56

### Workbench

- Worktop made of painted sheet metal with external edge
- Steel frame with 6 supporting legs
- Static load capacity: 1200 kg
- Matches panel toolholder C57P; cannot be fixed to worktop
- Two drawers with lock
- Can be fixed to floor



	C56-O 82 kg 056000201	
	C56-G 82 kg 056000202	
	C56-R 82 kg 056000203	

# SPECIAL mobile roller cab

- Multi-ply wood worktop
- Front centralized safety lock
- 4 castors, Ø 125 mm: 2 fixed and 2 steering (one with brake), with exposed covering
- Static load capacity: 1200 kg
- Drawer bases protected by foamed rubber mats
- Opening system throughout length of drawer
- Drawer front made of aluminium



## C39SM

### Special mobile roller cab, Racing SM type

7-drawer module 588x367 mm, with ball bearing slides:  
6 drawers, 70 mm high  
1 drawer, 240 mm high

Service module

- Integrated wastepaper basket
- Paper roll compartment
- 1 large drawer (380x305x270 mm)

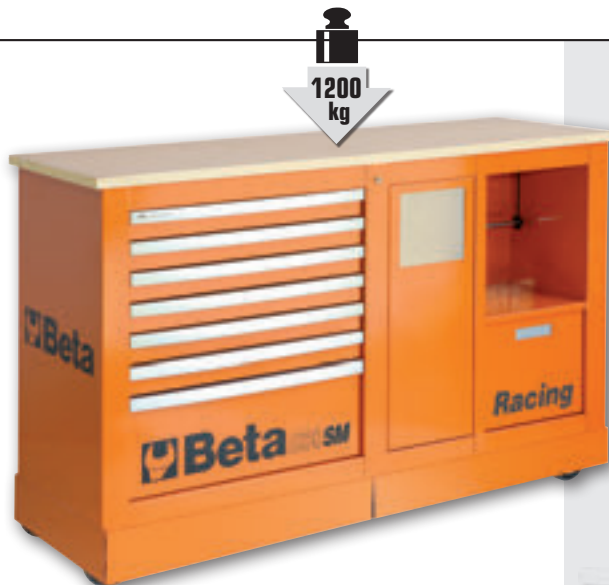

h	max
70 mm	30 kg
240 mm	40 kg

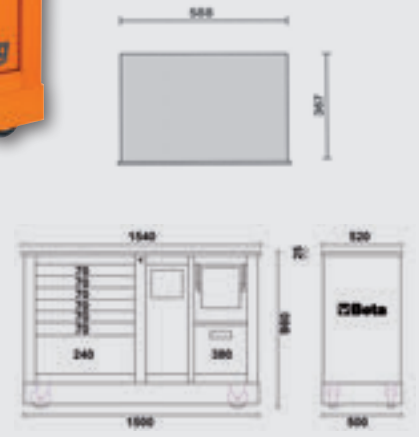

Color	Weight	Code
Orange	125 kg	039390001
Grey	125 kg	039390002
Red	125 kg	039390003

## C39MD

### Special mobile roller cab, Racing MD type

7-drawer module 588x367 mm, with ball bearing slides:  
6 drawers, 70 mm high  
1 drawer, 240 mm high

2-drawer module  
588x367x270 mm  
and 588x367x380 mm,  
with ball bearing slides

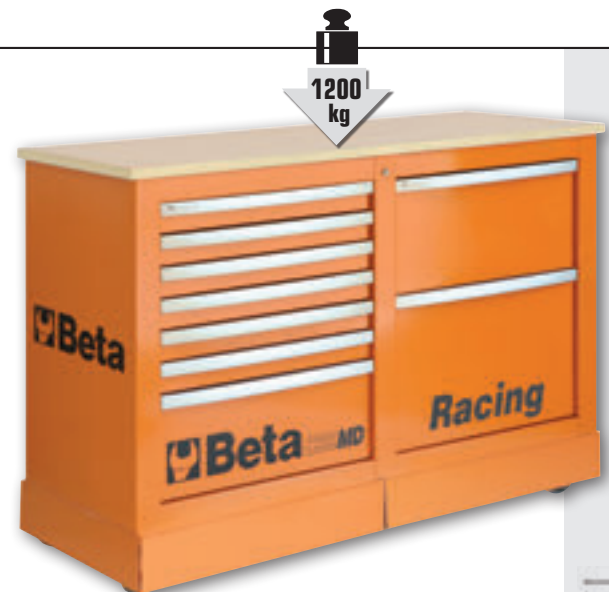

h	max
70 mm	30 kg
240 mm	40 kg

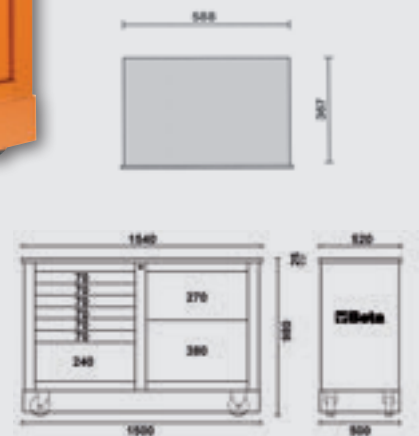

Color	Weight	Code
Orange	123 kg	039390101
Grey	123 kg	039390102
Red	123 kg	039390103



# WORKSHOP EQUIPMENT C55



The modular workshop combination that allows you to create a modern work environment customized to fit your space and storage needs. Choose from a wide range of solutions sharing high quality standards, designed to make the most of your time by optimizing work.

- Quality: Beta's best "Made in Italy" quality to furnish your workshop.
- Space organization: A rationally organized workbench system as synonymous with optimized work.
- Design: Refined finish to make your workplace a neat, aesthetically captivating environment.
- Modularity: Modular workshop system, customized to fit your space and storage needs.

## C55AB

### Workshop equipment combination

Combination comprising:

- Two-door tool cabinet (C55A2)
- Workbench (C55BO/2)
- Fixed module with 7 drawers (C55M7)
- Fixed service module (C55MS)
- Tool panel with suspended cabinets (C55/2PM)

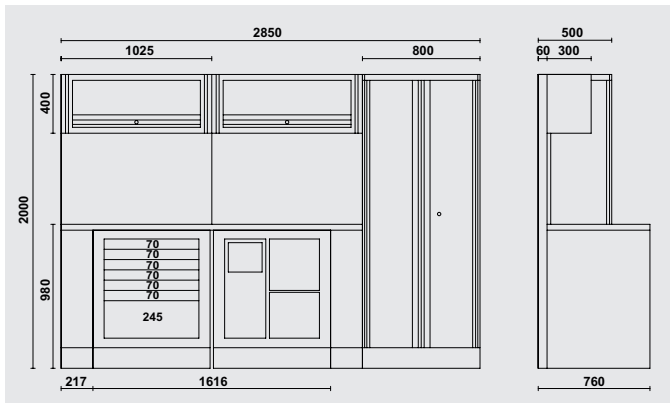

## C55PB/3

### Workshop equipment combination

Combination comprising:

- Workbench (C55BO/2)
- Mobile roller cab module with 8 drawers (C55C8)
- Fixed module with 2 storage drawers (C55M2)
- Wall tool system with shutter (C55PS-0)

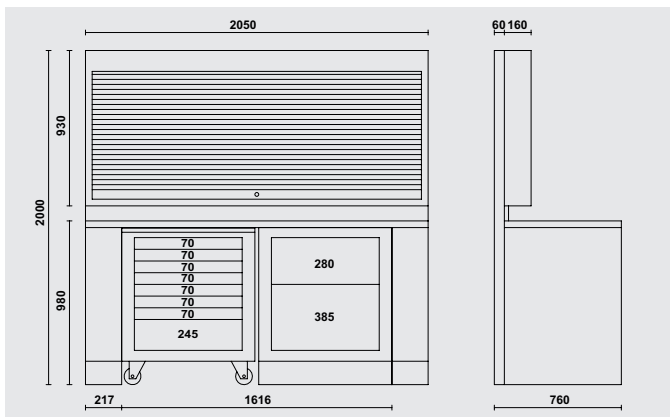

# WORKSHOP EQUIPMENT C55

Combination comprising:

- Fixed module with 7 drawers 566x406 mm
- Fixed service module
- Fixed two-door module
- 3 wall-mounted cabinets
- 3 perforated tool panels
- 2 wall brackets, wide type
- 2 wall brackets, narrow type

## C45/AX

### Workshop equipment combination C45/AX

- Worktop made of coated MDF stainless steel (C45PX/3-2,OMT)

## C45/AW

### Workbenches for workshop equipment combination C45

- Multi-ply wood worktop (C45PW/3-2,OMT)

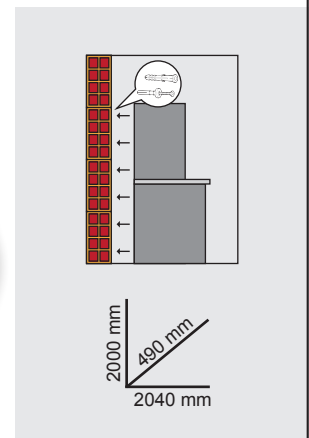

C45/AX	206 kg	045000030
C45/AW	172 kg	045000040

Combination comprising:

- Fixed module with 7 drawers 566x406 mm
- Fixed service module
- Single-door tool cabinet
- 2 wall-mounted cabinets
- 2 perforated tool panels
- 2 wall brackets, wide type
- 1 wall bracket, narrow type

## C45/CX

### Workshop equipment combination C45/CX

- Worktop made of coated MDF stainless steel (C45PX/2-1,3MT)

## C45/CW

### Workshop equipment combination C45/CW

- Multi-ply wood worktop (C45PW/2-1,3MT)

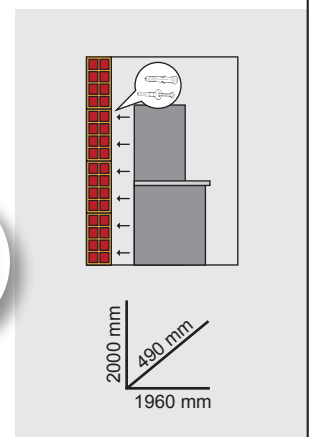

C45/CX	275 kg	045000063
C45/CW	260 kg	045000073

## C5 - 2105

### Tool rucksack made of technical fabric, empty

- Removable interior tool panel
- Six functional exterior pockets
- Two capacious interior pockets
- Waterproof plastic base
- Double safety lace for fixing rucksack to shoulders
- Ergonomic padded back



C5 2,5 kg 021050000

## 2250-0

### Heavy duty swivel creeper seat with tray

- Round swivel seat
- Height can be adjusted through a gas piston mechanism (410-530 mm)
- 5 pivoting castors
- 2 tote/tool trays, one being vertically adjustable

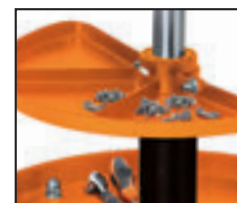

410-530 mm  
380 mm  
380 mm

2250-0 6 kg 022500011

## 3002

### Creeper and seat

- Steel frame
- PVC lining with upholstery
- Easily convertible into a creeper or a seat



420 mm

100 mm

3002 8 kg 030020001

## Work mats

- Protects floor from oil and petrol leaks, environmentally friendly
- Easy to clean, anti-skid, rubber-coated bottom



### 9562T2

Workbench mat,  
200x160 cm

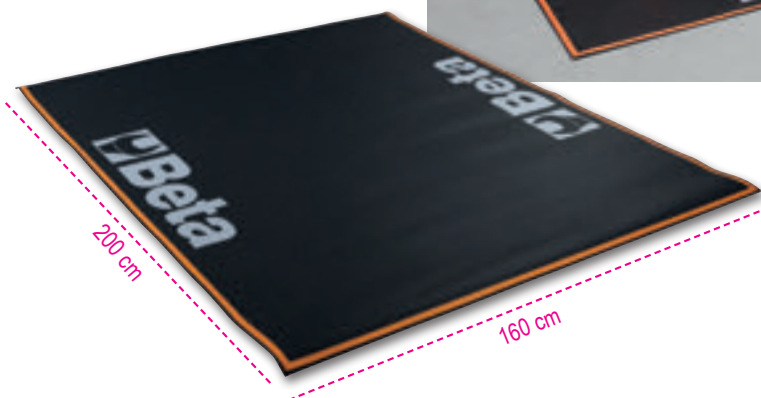

9562T2 095620200

### 9562T3

Garage mat  
300x160 cm

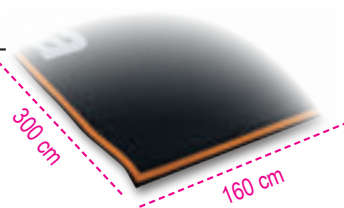

pag 55

- particularly suitable for use under motorcycle jacks

9562T3 095620300

### 9562P2

Multilogo mat  
200x80 cm

- particularly suitable for use with workshop equipment item C55 or under motorcycles

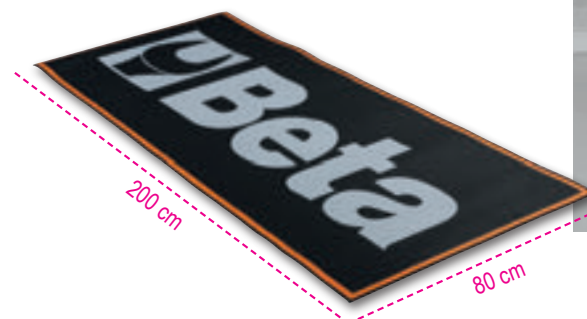

9562P2 095620400

### 9562P25

Multilogo mat roll  
12 m x 80 cm

- Allows mat length to be customized as needed

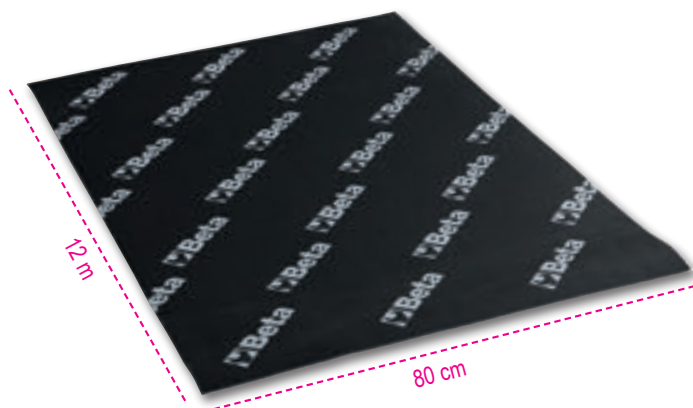

9562P25 095620425

# 5904VG/2M

## Assortment of 170 tools



M15 M16 VP/M3



M50 M55 M86



M208 M85 M234



M83 M131 M145

For C24S



Quantity/Description	Beta N.	TR	Quantity/Description	Beta N.	TR
16 combination wrenches 6+21 mm	42	M15	4 bits for cross head Pozidriv® - Supadriv® screws, coloured	860PZ	M85
5 combination wrenches 22 - 24 - 27 - 30 - 32 mm	42	M16	⊕ PZ1 - PZ2 - PZ3 - PZ4		
8 offset hexagon key wrenches ⌀ 2-2,5-3-4-5-6-7-8 mm	96T	M50	10 bits for Torx® head screws, coloured ⊕ T7-T8-T9-T10-T15-T20-T25-T27-T30-T40	860TX	M85
6 drivers for Torx® head screws, with handles ⊕ T10-T15-T20-T25-T27-T30	97TTX	M55	8 bits for Tamper Resistant Torx® head screws, coloured ⊕ T9-T10-T15-T20-T25-T27-T30-T40	860RTX	M85
7 hexagon bits ⌀ 4-5-6-7-8-10-12 mm	867PE	M86	1 magnetic bit holder with handle 230 mm	851SR	M85
7 hexagon bits ⌀ 4-5-6-7-8-10-12 mm	867PE/L	M86	1 reversible bit ratchet 100 mm	860/55	M85
5 bits with XZN® profile ⌀ 5-6-8-10-12 mm	867XZN	M86	2 flat chisels, ribbed type 100 - 200 mm	35	M234
5 bits with XZN® profile ⌀ 5-6-8-10-12 mm	867XZN/L	M86	1 engineer's hammer 300 g	1370	M234
7 bits for Torx® head screws ⊕ T20-T25-T30-T40-T45-T50-T55	867TX	M86	1 soft face hammer Ø 35 mm	1390	M234
6 bits for Torx® head screws ⊕ T25-T30-T40-T45-T50-T55	867TX/L	M86	1 1/2" wobble extension bar 125 mm	920AN/125	M83
7 bits for Tamper Resistant Torx® head screws ⊕ T20-T25-T30-T40-T45-T50-T55	867RTX	M86	1 1/2" wobble extension bar 250 mm	920AN/250	M83
1 bit holder sockets for item 867	867/1	M86	1 1/2" drive universal joint	920/25	M83
1 bit holder sockets for item 867	867/2	M86	1 1/2" drive sliding T-handle	920/42	M83
5 screwdrivers for cross head Phillips® screws ● 3x75 - 4x100 - 4x125 - 5,5x150 - 6,5x150 mm	1260	M208	1 1/2" drive reversible ratchet ⊕	920/55	M83
3 screwdrivers for cross head Phillips® screws ⊕ PH0x60 - PH1x80 - PH2x100 mm	1262	M208	19 1/2" square drive hexagon sockets ⌀ 10+24 - 26 - 27 - 30 - 32 mm	920A	M83
1 screwdrivers for slotted head screws, extra-short series ● 4x30 mm	1260N	M208	1 half-round needle nose pliers 180 mm	1150BM	M131
1 screwdrivers for cross head Phillips® screws, extra - short series ⊕ PH1x30 mm	1262N	M208	1 extra long needle knurled nose pliers, bi-material handles ● 160 mm	1166BM	M131
5 bits for slotted head screws, coloured ● 0,5x3 - 0,6x4,5 - 0,8x5,5 - 1x5,5 - 1,2x6,5 mm	860LP	M85	1 heavy duty diagonal cutting nippers ⚡ 160 mm	1084BM	M131
8 hexagon bits for power drivers, coloured ⌀ 2 - 2,5 - 3 - 4 - 5 - 6 - 8 - 10 mm	860PE	M85	1 circlip pliers straight, internal ⌀ 180 mm	1032	M145
5 bits for cross head Phillips® screws, coloured ⊕ PH0 - PH1 - PH2 - PH3 - PH4	860PH	M85	1 circlip pliers bent, internal ⌀ 170 mm	1034	M145
			1 circlip pliers straight, external ● 175 mm	1036	M145
			1 circlip pliers bent, external ● 175 mm	1038	M145
			1 soft thermoformed tray	VPM3	

## 5940SBK

### Assortment of 125 tools



#### Quantity/Description

#### Beta N.

1	drift punches Ø 2 mm	30
1	centre punch Ø 4 mm	32
1	flat chisels 125 mm	34
10	combination wrenches 6 - 7 - 8 - 10 - 11 - 12 - 13 - 14 - 17 - 19 mm	42
6	double open end wrenches 6x7 - 8x9 - 10x11 - 12x13 - 14x15 - 16x17 mm	55
9	offset hexagon key wrenches $\odot$ 1,5 - 2 - 2,5 - 3 - 4 - 5 - 6 - 8 - 10 mm	96/SC9
1	click type torque wrench 3/8", 8+60 Nm	666N/5
54	assortment of 52 hexagon bits, 10 mm, and 2 accessories	867/C52
17	assortment of 12 sockets and 5 accessories	920A/C12X
1	adaptor, 1/2" female and 3/8" male drives	910/16
2	3/8" square drive spark plug sockets $\odot$ 16 - 17,8 mm	956E
1	extra - long nose pliers $\bullet$ 283 mm	1009L/A
2	circlip pliers straight, internal $\odot$ 140 - 180 mm	1032
1	circlip pliers straight, external $\bullet$ 140x1,3 mm	1036
1	diagonal cutting nippers $\angle$ 160 mm	1082
1	electrician's scissors, straight blades	1128BM
1	half-round needle nose pliers $\equiv$ 180 mm	1150
1	screwdriver for Dzusz <sup>®</sup> head screws $\bullet$	1201DZ
4	screwdrivers for cross head Phillips <sup>®</sup> screws $\bullet$ 3x75 - 4x100 - 5,5x100 - 6,5x150 mm	1201
3	screwdrivers for cross head Phillips <sup>®</sup> screws $\oplus$ PH0x60 - PH1x80 - PH2x100 mm	1202
1	circuit testing screwdriver $\bullet$	1254
1	engineer's hammer 300 g	1370
1	adjustable oil filter wrench	1491
1	metric feeler gauge	1708/13
1	mini hacksaw frame	1725CR
1	brush, brass wires	1737
1	plastic oil can 250 cc	1754

For C41S and C41H



    
5940SBK 13 kg 059400081



**34** For C22, C23S, C23SC e C27S  
**MC10**



- 42 6-7-8-9-10-11-12-13-14-15-16-17-18-19-21-22 mm
- 96/SC9 1,5-2-2,5-3-4-5-6-8-10 mm
- 1084BM 160 mm
- 1150BM 180 mm
- 1166BM 160 mm
- 1201 3,5x100-5,5x150-6,5x150 mm
- 1202 PH0x60-PH1x80-PH2x100 mm

3,5 kg 027500010

**24** For C41H  
**MC21**



- 920A 10-11-12-13-14-15-16-17-18-19-20-21-22-23-24-26-27-30-32 mm
- 920/25
- 920/42
- 920/55
- 920AN 125-250 mm

4,3 kg 041500021

**27** **M31**



- 42AS 1/4-9/32-5/16-3/8-7/16-1/2-9/16-19/32-5/8-11/16-3/4-13/16-7/8-15/16-1-1.1/16-1.1/8-1.1/4
- 96BP/AS-SC9 1/16-3/32-1/8-5/32-3/16-7/32-1/4-5/16-3/8

4,5 kg 024500031

**17** **M33**



- 55 6x7-8x9-10x11-12x13-14x15-16x17-18x19-20x22 mm
- 96/SC9 1,5+10 mm

1,1 kg 024500033

**14** For C22, C23S, C23SC e C27S  
**MC20**



- 860MIX/A31
- 895/1
- 1048 250 mm
- 1370 300 g
- 32 Ø 4 mm
- 36 Ø 4 mm
- 900 4-4,5-5-5,5-6-7-8-9-10-11-12-13-14 mm
- 900/21 150 mm
- 900/25
- 900BG/30C
- 900/42
- 900/55
- 920A 10-11-12-13-14-15-16-17-18-19-21-22-24-27-30-32 mm
- 920/25
- 920AN/125 125 mm
- 920/42
- 920/55

6 kg 027500020

For C24S, C39, C55

**16** **M15**



- 42 6-7-8-9-10-11-12-13-14-15-16-17-18-19-20-21 mm

1,5 kg 024500015

**12** **M46**



- 142SN 8-9-10-11-12-13-14-15-16-17-18-19 mm

1,4 kg 024500046

**8** **M50**



- 96T 2-2,5-3-4-5-6-7-8 mm

1,1 kg 024500050

**26** For C41H  
**MC11**



- 42 6-7-8-9-10-11-12-13-14-15-16-17-18-19-21-22 mm
- 96/SC9 1,5-2-2,5-3-4-5-6-8-10 mm
- 1692/5 5 m

2,2 kg 041500011

**40** **M25**



- 42 6-7-8-9-10-11-12-13-14-15-16-17-18-19-21-22-24-27 mm
- 90 6x7-8x9-10x11-12x13-14x15-16x17-18x19 mm
- 123Q1/4
- 123Q3/8
- 123Q1/2
- 142 8-9-10-11-12-13-14-15-16-17-18-19 mm

5 kg 024500873

**5** **M55**

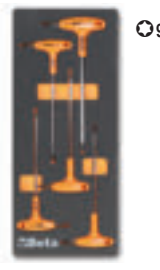

- 97TTX T10-T15-T20-T25-T30

330 g 024500055

## 21 M62



- 97TTX T10-T15-T20-T25-T27-T30-T40-T45-T50 **1038** 175 mm
- 1032** 180 mm
- 1034** 170 mm
- 1036** 175 mm
- 1177BM** 140 mm
- 1188BM** 125 mm
- 1257LP** 2-2,5-3-3,5 mm
- 1257PH** 0-00

**2,4 kg** **024500875**

## 16 M65

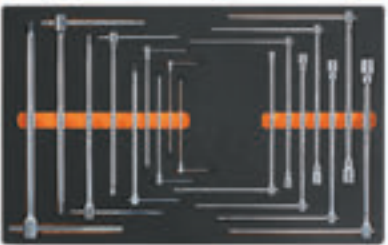

- 950** 8-10-12-13-14-17-19 mm
- 951** 2,5-3-4-5-6-8-10-12-14 mm

**3,6 kg** **024500065**

## 9 M69



- **951** 2,5-3-4-5-6-8-10-12-14 mm

**1,8 kg** **024500069**

## 24 M83 12"



- **920A** 10-11-12-13-14-15-16-17-18-19-20-21-22-23-24-26-27-30-32 mm
- 920AN/125** 125 mm
- 920AN/250** 250 mm
- 920/25** 255 mm
- 920/42** 305 mm
- ⊗ **920/55**

**3,7 kg** **024500083**

## 45 M85 14"



- 851SR** 230 mm
- **860LP** 0,5x3 - 0,6x4,5 - 0,8x5,5 - 1x5,5 - 1,2x6,5 mm
- **860PE** 2-2,5-3-4-5-6-8-10 mm
- ⊕ **860PH** PH0-PH1-PH2-PH3-PH4
- ⊕ **860PZ** PZ1 - PZ2 - PZ3 - PZ4
- ⊕ **860TX** T6-T7-T8-T9-T10-T15-T20-T25-T27-T30-T40
- ⊕ **860RTX** T9-T10-T15-T20-T25-T27-T30-T40
- 860/55** 100 mm
- 882P** 80 mm

**450 g** **024500085**

## 46 M86 10"



- **867PE** 4-5-6-7-8-10-12 mm
- **867PE/L** 4-5-6-7-8-10-12 mm
- **867XZN** 5-6-8-10-12 mm
- **867XZN/L** 5-6-8-10-12 mm
- ⊕ **867TX** T20-T25-T30-T40-T45-T50-T55
- ⊕ **867TX/L** T25-T30-T40-T45-T50-T55
- ⊕ **867RTX** T20-T25-T30-T40-T45-T50-T55
- 867/1**
- 867/2**

**1,4 kg** **024500086**

## 25 M91 14"



- **900** 4-4,5-5-5,5-6-7-8-9-10-11-12-13-14 mm
- **900ME** 2,5-3-4-5-6-8 mm
- 900/20** 50 mm
- 900/21** 150 mm
- 900/25** □ 1/4 - ■ 1/4
- 900BG/30**
- 900/42**
- ⊗ **900/55**

**560 g** **024500091**

## 22 M92 38"



- **910A** 6-7-8-9-10-11-12-13-14-15-16-17-18-19-20-21-22 mm
- 910/21** 125 mm
- 910/22** 250 mm
- 910/25**
- 910/42**
- ⊗ **910/55**

**1,5 kg** **024500092**

## 116 M105 14" 38" 12"



- **900** 4-4,5-5-5,5-6-7-8-9-10-11-12-13-14 mm
- **900L** 5-6-7-8-9-10-11-12-13 mm
- **96BPC/SC9** 1,5-2-2,5-3-4-5-6-8-10 mm
- 895/1**
- 895/3**
- 895/6**
- **900ME** 3-4-5-6-7 mm
- **900LP** 0,8x4-1x5,5-1,2x6,5-1,2x8 mm
- ⊕ **900PH** PH1-PH2-PH3-PH4
- ⊕ **900TX** T10-T15-T20-T25-T27-T30-T40
- 900/16** □ 1/4 - ■ 3/8
- 900/...** 50-100-150 mm
- 900/25**
- 900BG/30**
- 900/42**
- ⊗ **900/55**
- **910A** 6-7-8-9-10-11-12-13-14-15-16-17-18-19-20-21-22 mm
- 910/15** □ 3/8 - ■ 1/4
- 910/16** □ 3/8 - ■ 1/2
- 910/21** 125 mm
- 910/22** 250 mm
- 910/25**
- 910/42**
- ⊗ **910/55**
- **920A** 8-10-11-12-13-14-15-16-17-18-19-20-21-22-23-24-26-27-28-30-32 mm
- 1/2 - ■ 3/8
- 920/15**
- 920/25**
- 920AN** 125 - 250 mm
- 920/42**
- ⊗ **920/55**
- **956E** 16-17,8-20,8 mm

**7,6 kg** **024500871**

## 68 M125 38" 12"



- **910AL** 8-9-10-11-12-13-14-15-16-17-19-21-22 mm
- **920PE** 5-6-6L-7-8-8L-10-10L-12-12L mm
- **920FTX** E12-E14-E16-E18-E20-E22-E24
- ⊕ **920TX** T20-T25-T27-T30-T30L-T40-T40L-T45-T50-T50L-T55-T60-T60L
- **920XZN** 5-6-6L-8-8L-10-10L-12L mm
- **920AL** 10-12-13-14-15-16-17-18-19-21-22-23-24-27-30-32 mm
- 1692/5** 5 m

**7,8 kg** **024500872**



### 13 M130



- 1032 180 mm      1112 250 mm
- 1034 170 mm      1128BM
- 1036 175 mm      1150BM 180 mm
- 1038 175 mm      1166BM 160 mm
- 1048 250 mm      1168BM 160 mm
- 1052 240 mm
- 1082BM 160 mm
- 1098 220 mm

3,4 kg 024500130

### 3 M131



- 1084BM 160 mm
- 1150BM 180 mm
- 1166BM 160 mm

750 g 024500131

### 4 M145



- 1032 180 mm
- 1034 170 mm
- 1036 175 mm
- 1038 175 mm

640 g 024500145

### 2 M153



- 1048 250 mm
- 1052 240 mm

1 kg 024500153

### 6 M204



- 1267TX T8-T10-T15-T20-T25-T30

450 g 024500204

### 10 M208



- 1260 3x75 - 3,5x100  
4x125 - 5,5x150  
6,5x150 mm
- 1262 PH0x60  
PH1x80  
PH2x100 mm
- 1260N 4x30 mm
- 1262N PH1x30 mm

750 g 024500208

### 25 M210



- 1201 2,5x50-3x75-4x100-5,5x125-6,5x150-8x200 mm
- 1201N 4x30 mm
- 1202 PH0x60-PH1x80-PH2x100-PH3x150 mm
- 1202N PH1x30 mm
- 1207TX T6-T7-T8-T9-T10-T15-T20-T25-T27-T30-T40-T45
- 1253

1,8 kg 024500210

### 25 M230

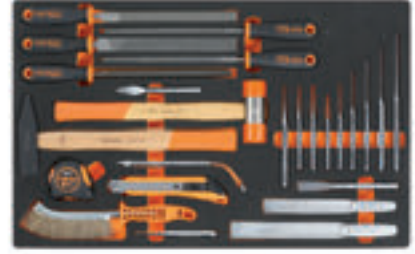

- 30 Ø 2-3-4 mm
- 31 Ø 2-3-4-5-6-8 mm
- 32 Ø 4 mm
- 34 150 mm
- 35 200-250 mm
- 36 125 mm
- 1370 500 g
- 1390 Ø 35 mm
- 1692 3 m
- 1712TF
- 1771 18 mm
- 1719BMA/Q 200 mm
- 1719BMA/T 200 mm
- 1719BMA/P 200 mm
- 1719BMA/M 200 mm
- 1719BMA/R 200 mm
- 1737NX
- 1771 18 mm

3,2 kg 024500230

### 4 M234



- 35 100-200 mm
- 1370 300 g
- 1390 Ø 35 mm

1,3 kg 024500234



















# Reversible screwdrivers

## 1281BG/B28A 1 1/4"

Set of 16 reversible screwdrivers  
9 1/4" drive sockets,  
2 accessories and 1 handle,  
in wallet











	900	4 - 4,5 - 5 - 5,5 6 - 7 - 8 - 9 - 10 mm
	1281BG	
	1281PB	■ 1/4
	900/25	
	1281LP/1	0,8x4 - 1,2x6,5 mm
	1281LP/2	1,0x5,5 - 1,2x6,5 mm
	1281PH/1	PH1 - PH2
	1281PH/2	PH2 - PH3
	1281PZ/1	PZ1 - PZ2
	1281PZ/2	PZ2 - PZ3
	1281PE	2,5 - 3 - 4 - 5 - 6 mm
	1281TX/1	T6 - T8
	1281TX/2	T7 - T9
	1281RTX/3	T10 - T15
	1281RTX/4	T20 - T25
	1281RTX/5	T30 - T40

   
1281BG/B28A 1,1 kg 012810510

## 1281BG-TX/A8 1 1/4"

Assortment of 8 reversible  
screwdrivers and 1 accessory  
in case

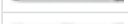











	1281BG	
	1281LPH/1	PH0-0,8x4 mm
	1281LPH/2	PH1-1x5,5 mm
	1281LPH/3	PH2-1,2x6,5 mm
	1281TX/1	T6-T8
	1281TX/2	T7-T9
	1281TX/3	T10-T15
	1281TX/4	T20-T25
	1281TX/5	T30-T40

   
1281BG-TX/A8 527 g 012810530

## 1281BG/A9 1 1/4"

Assortment of 9 reversible  
screwdrivers and 1 accessory  
in case



	1281BG	
	1281LPH/1	PH0-0,8x4 mm
	1281LPH/2	PH1-1x5,5 mm
	1281LPH/3	PH2-1,2x6,5 mm
	1281PZ/1	PZ1-PZ2
	1281PE	2,5 mm
	1281PE	3 mm
	1281PE	4 mm
	1281PE	5 mm
	1281PE	6 mm

   
1281BG/A9 567 g 012810520

# Wrenches



## 950

### T-handle hexagon socket wrenches

- Sliding handle, which can be stopped in the required position throughout its length.
- Safety catch, which prevents the handle from coming out, thereby avoiding accidents.
- Triple size marking on head.

UNI 6742 DIN 3112

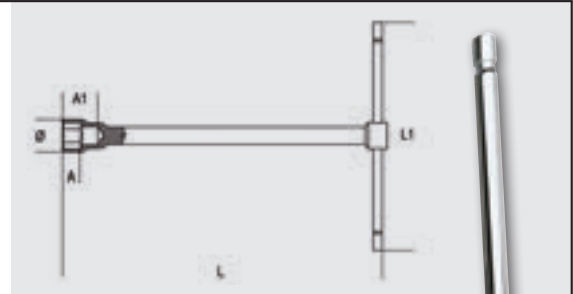

mm	L mm	Ø mm	L1 mm	A mm	A1 mm	g		mm	L mm	Ø mm	L1 mm	A mm	A1 mm	g	
6	210	10,1	145	5,0	16,0	98	009500006	14	250	20,1	190	11,5	25,0	289	009500014
7	212	11,2	145	6,0	18,0	100	009500007	15	254	21,5	190	12,0	25,0	307	009500015
8	220	12,4	160	7,0	19,0	140	009500008	16	260	22,7	200	12,5	26,0	414	009500016
9	223	13,5	160	8,0	20,0	142	009500009	17	264	24,1	200	13,0	27,0	436	009500017
10	230	14,9	160	8,5	21,0	172	009500010	19	274	26,6	230	14,5	29,0	553	009500019
11	233	16,1	160	9,0	22,0	176	009500011	22	290	29,9	290	16,0	32,0	797	009500022
12	240	17,5	175	9,5	23,0	228	009500012	24	300	32,2	320	18,0	36,0	976	009500024
13	244	19,7	175	10,5	24,0	233	009500013	27	315	36,2	370	21,0	42,0	1265	009500027

### Set of T-handle hexagon socket wrenches

950/S9

7-8-10-11-12-13-14-17-19 mm



2,3 kg



009500079

950/14

6-7-8-9-10-11-12-13-14-15-16-17-19-22 mm



4,1 kg



009500082



## 951

### T-handle wrenches with three hexagon male ends

- Designed to develop high pairs.
- Calibrated hexagonal ends.
- The sliding block can be stopped in the desired position through the whole length; the safety clutches retain the shafts thus preventing any accidents

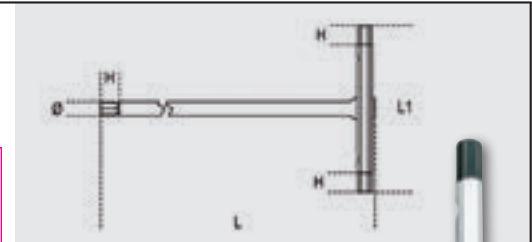

mm	L mm	L1 mm	Ø mm	H mm	g		mm	L mm	L1 mm	Ø mm	H mm	g	
2	125	63	4,0	5,5	20	009510521	6	215	99	8,0	10	117	009510560
2,5	150	63	4,0	6	20	009510525	7	230	109	9,0	11	163	009510570
3	150	63	4,0	6,5	22	009510530	8	250	122	10,0	12	219	009510580
3,5	175	76	5,5	7,5	46	009510535	9	265	132	11,0	13	289	009510590
4	175	76	5,5	8	47	009510540	10	280	142	12,0	14	371	009510610
4,5	195	87	6,5	8,5	75	009510545	12	305	160	15,0	15	613	009510620
5	195	87	6,5	9	76	009510550	14	330	178	17,0	17	884	009510640

## Set of T-handle wrenches with three hexagon male ends

**951/S8** 2-2,5-3-3,5-4-4,5-5-6 mm 400 g 009510693

**951/S14** 2-2,5-3-3,5-4-4,5-5-6-7-8-9-10-12-14 mm 3,1 kg 009510695

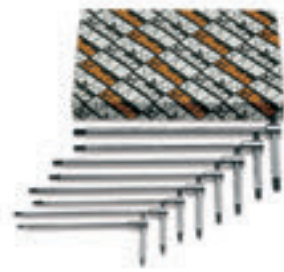

## **951TX**

### T-handle wrenches with three male ends for Torx® head screws

- Designed to develop high pairs.
- Calibrated hexagonal ends.
- The sliding block can be stopped in the desired position through the whole length; the safety clutches retain the shafts thus preventing any accidents

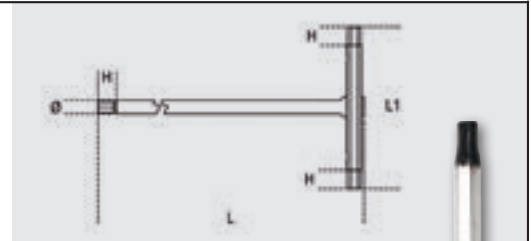

Ø	L mm	L1 mm	Ø mm	H mm	g	
T6	125	63	4	3,5	20	009510806
T7	125	63	4	3,5	20	009510807
T8	125	63	4	3,5	20	009510808
T9	125	63	4	3,5	20	009510809
T10	150	63	4	4	23	009510810
T15	150	63	4	4,2	22	009510815
T20	175	76	5	4,5	46	009510820

Ø	L mm	L1 mm	Ø mm	H mm	g	
T25	175	76	5	5	47	009510825
T27	195	87	6	5,5	74	009510827
T30	195	87	6	6,3	75	009510830
T40	215	99	7	6,5	115	009510840
T45	230	109	8	7,5	159	009510845
T50	250	122	9	9	215	009510850

## Set of offset key wrenches for Torx® head screws®

**951TX/S6** T8-T10-T15-T20-T25-T30 0,5 kg 009510866

**951TX/S13** T6-T7-T8-T9-T10-T15-T20-T25-T27-T30-T40-T45-T50 1 kg 009510863

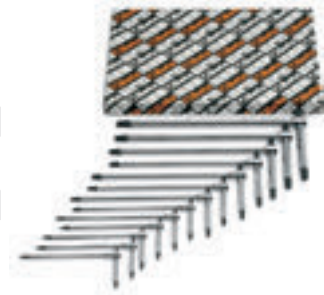







## Socket sets and accessories

### **860/C27**

25 bits, 1 connector and 1 reversible ratchet in plastic case



	860/55	100 mm
	860/LP	0,5x3-1,0x5,5-1,2x6,5 mm
	860/PH	PH1-PH2(x2)-PH3
	860/PZ	PZ1-PZ2(x2)-PZ3
	860/PE	2-2,5-3-4-5-6 mm
	860/TX	T6-T8-T10-T15-T20-T25-T30-T40
	892/0	● 1/4 ■ 1/4

150x95x50 mm **860/C27** 785 g 008600880

## 900/C39

Assortment of  
11 hexagon sockets,  
21 bits and 7 accessories,  
in plastic case



14" 1/4"

	861LP	0,6x4,5-1,2x6,5-1,2x8 mm
	861PH	PH1-PH2-PH3
	861PZ	PZ1-PZ2-PZ3
	861PE	2,5-3-4-5-6 mm
	861RTX	T10-T15-T20-T25-T27-T30-T40
	900	5-5,5-6-7-8-9-10-11-12-13-14 mm
	900/20	50 mm
	900/20L	100 mm
	900/25	
	900BG/30C	
	900/55	
	892/0	
	895/1	

150x95x50 mm 900/C39 785 g 009000937

## 900/C12MR

Assortment of  
12 hexagon sockets,  
20 bits and 7 accessories  
in metal case

- Reversible ratchet with rotating handle



14" 1/4"

	861LP	0,5x3-0,8x5,5-1x5,5-1,2x6,5 mm
	861PE	3-4-5-6-8 mm
	861PH	PH0-PH1-PH2-PH3
	861TX	T8-T10-T15-T20-T25-T30-T40
	895/1	□1/4" - □1/4"
	900	4-5-5,5-6-7-8-9-10-11-12-13-14 mm
	900/20	50 mm
	900/21	150 mm
	900/25	
	900/42	
	900BG/30	
	900/58	

350x150x50 mm 900/C12MR 1,3 kg 009000962

## 910A/C16HR

Assortment of  
16 hexagon sockets  
and 5 accessories  
in metal case

- Reversible ratchet with rotating handle



3/8"

	910A	6-7-8-9-10-11-12-13-14-15-16-17-18-19-21-22 mm
	910/21	125 mm
	910/22	250 mm
	910/25	
	910/42	
	910/58	

335x145x60 mm 910A/C16HR 2,4 kg 009100935

## 920A/C17MR

Assortment of  
17 hexagon sockets  
and 5 accessories  
in foam tray,  
in metal case

- Reversible ratchet with rotating handle



1/2"

	920A	10-11-12-13-14-15-16-17-18-19-20-21-22-24-27-30-32 mm
	920/21	125 mm
	920/22	255 mm
	920/25	
	920/42	
	920/58	

420x185x60 mm 920A/C17MR 5,1 kg 009200937

**941**

**Hexagon / bi-hex socket wrenches with high torque handles**

- Deep, hi-torque hexagon nut spinner on long side

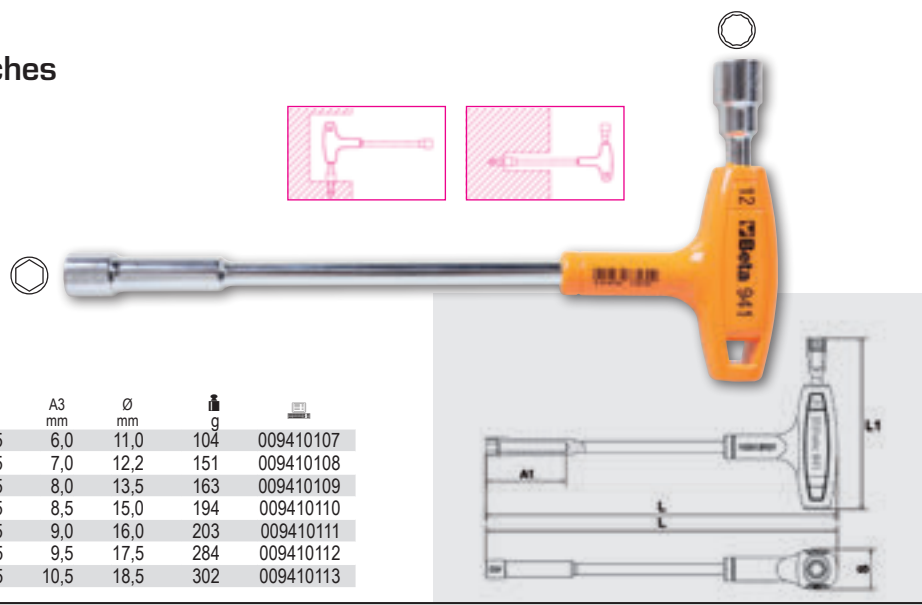

mm	L mm	L1 mm	A1 mm	A mm	S mm	A2 mm	A3 mm	Ø mm	g	
7x7	200	91	35	6,0	20,6	15,5	6,0	11,0	104	009410107
8x8	220	107	50	7,0	25,2	18,5	7,0	12,2	151	009410108
9x9	220	109	50	8,0	25,2	19,5	8,0	13,5	163	009410109
10x10	236	111	50	8,5	25,2	20,5	8,5	15,0	194	009410110
11x11	236	114	50	9,0	25,2	21,5	9,0	16,0	203	009410111
12x12	255	122	50	9,5	27,6	22,5	9,5	17,5	284	009410112
13x13	255	124	55	10,5	27,6	23,5	10,5	18,5	302	009410113

**943FL**

**Flexible hexagon nut spinners with handles**



mm	L mm	L1 mm	Ø mm	A mm	A1 mm	g	
5	265	150	8	6,0	14,0	176	009430304
5,5	265	150	8	6,5	14,0	176	009430305
6	265	150	9	6,5	14,0	178	009430306
7	265	150	11	6,5	14,0	177	009430307
8	265	150	12	6,5	14,0	179	009430308
10	290	175	14	7,5	14,0	179	009430310

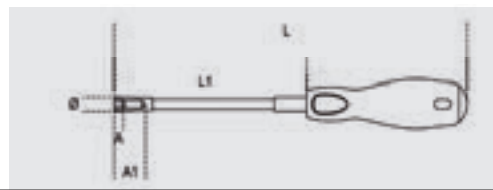

**Set of flexible hexagon nut spinners with handles**

**943FL/S6** 5-5,5-6-7-8-10 mm 1 kg 009430320



**Pullers**

**1433/C11**

**Set of 11 roller stud extractors with 1/2" female square and hexagon drives in metal case with soft thermoformed tray**

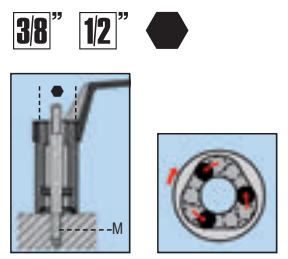

340x135x56 mm	1433/C11	M5 - M6 - M7 - M8 - M9 - M10 - M10,5 - M11 - M12 - M14 - M16	19mm (M5) 21 mm (M6÷M12) 24 mm (M14-M16)	3,0 kg	014330311
---------------	----------	--	--	--------	-----------

## 1430/S5

Set of tapered extractors for broken right-hand screws and studs in plastic case

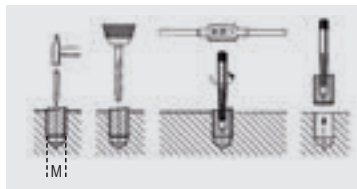

1430/S5 M3÷M18 133 g 014300105

## 1500N

Universal pullers with 2 sliding legs

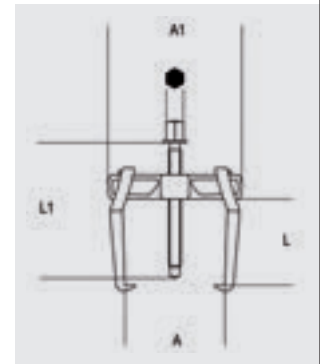

	A min÷Max mm	L mm	L1 mm	● mm	A1 mm	g	
1500N/0	18÷65	70	100	15	110	400	015000600
1500N/1	23÷70	100	130	17	130	700	015000601
1500N/2	23÷100	100	130	17	160	800	015000602
1500N/3	35÷140	150	190	20	230	2200	015000603
1500N/4	35÷190	150	190	20	280	2400	015000604
1500N/5	43÷250	205	295	27	360	5700	015000605
1500N/6	43÷320	205	295	27	430	6200	015000606

## 1535/C...

Puller kits in metal case

- Combination of pullers 1533, extensions 1533PR and separators 1534.
- For use where legged pullers would damage workpiece.



	g	
1535/C1	2,5 kg	015350001
260x180x40 mm		
1533/2	L mm	A min÷max mm
1533PR/1	100	
1534/1	88	5÷60

	g	
1535/C2	2,8 kg	015350002
260x180x40 mm		

	L mm	A min÷max mm
1533/2	150	45÷130
1533PR/1	100	
1534/2	118	12÷75

	g	
1535/C3	8,0 kg	015350003
380x280x55 mm		

	L mm	A min÷max mm
1533/3	210	85÷225
1533PR/2	100	
1534/3	118	22÷115

	g	
1535/C4	14,8 kg	015350004
420x380x65 mm		

	L mm	A min÷max mm
1533/4	175	80÷310
1533PR/3	100	
1534/4	205	25÷155

	g	
1535/C5	27,4 kg	015350005
530x510x85 mm		

	L mm	A min÷max mm
1533/5	235	145÷370
1533PR/3	100	
1534/5	290	30÷220

## 1545/C5M

Puller 1542/1 with 5 extractors 1544 in metal case

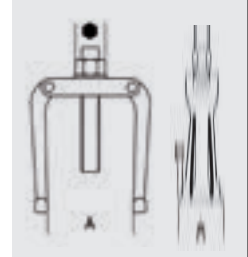
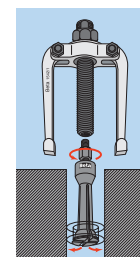

	A min÷Max mm	● mm	C mm
1544/1	9÷12	0,80	
1544/2	13÷17	1,15	
1544/3	16÷21	1,70	
1544/4	20÷25	1,65	
1544/5	25÷30	2,00	

265x180x45 mm 1545/C5M 2,4 kg 015450011

# Maintenance

## 31/B6

Set of 6 pin punches in wallet



31/B6	2-3-4-5-6-8 mm	509 g	000310020
-------	----------------	-------	-----------

## 99SQ

Hook wrenches with square noses for ring nuts



	mm	S mm	L mm	B mm	g	
99SQ 15-35	15-35	5,1	168	2,7	88	000990215
99SQ 35-50	35-50	6,0	208	3,5	156	000990235
99SQ 50-80	50-80	8,0	282	4,7	377	000990250
99SQ 80-120	80-120	8,3	344	6,2	667	000990280
99SQ 120-180	120-180	10,8	476	7,8	1400	000990290

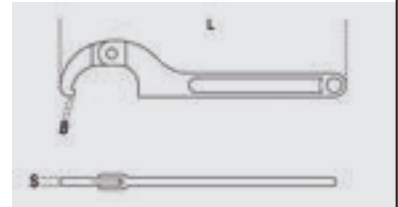

## 437U/09

Assortment for repairing damaged threads

- M5X0,8
- M6X1,0
- M8X1,25
- M10X1,5
- M12X1,75



25x M5, M6, M8, M10  
10x M12

370x230x55 mm

437U/09	M5X0,8 - M6X1,0 M8X1,25 - M10X1,5 M12X1,75	2,7 kg	004370550
---------	--	--------	-----------

## 437C

Set for repairing damaged spark plug threads, M14x1,25 mm

- Helicoids height: 8,40 - 12,40 - 16,40 mm (5 pcs/size)



M14 x 1,25 mm				
	5x	5x	5x	

437C	1,1 kg	004370100
------	--------	-----------



**1254**

Circuit testing screwdriver 6÷24V



	SxAxL mm	L mm	g	012540001
1254	0,5x3x44	123	30	012540001

**1295/C14**

Impact screwdriver with 14 insets and 1 socket holder

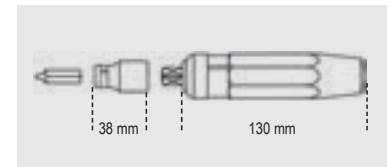

	170x100x35 mm	1295/C14	1,3 kg	012950108
	170x100x35 mm	1295/C14	1,3 kg	012950108

**1481PL/S3**

Set of 3 plastic hose pliers



	1481PL-A Ø 8÷15 mm	240 g	014810200
1481PL/S3	1481PL-A Ø 8÷15 mm	240 g	014810200
	1481PL-B Ø 15÷25 mm		
	1481PL-C Ø 25÷45 mm		

**1599P**

Parallel bench vices

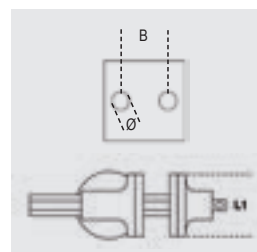

	L1 mm	B mm	Ø mm	kg	015990000
1599P 100	100	92	11	7.3	015990000
1599P 125	125	108	13	11.5	015990025
1599P 150	150	130	15	20.5	015990050

**1599G**

Pairs of aluminium jaw covers



	A mm	g	015990910
1599G 100	100	183	015990910
1599G 125	125	222	015990912
1599G 150	150	260	015990915
1599G 180	180	302	015990917

## 1712E/L1

Flexible magnetic pick-up tool with LED light





	L mm	D mm	F kg		
1712E/L1	500	11	0,75	500 g	017120111

## 1712E

Flexible magnetic pick up tools



	L mm	D mm	F kg		
1712E/1	420	7,5	0,5	145	017120011
1712E/2	530	15	1,8	232	017120012
1712E/3	532	19	3,0	239	017120013



## 1712TF

Telescopic magnet with flexible head

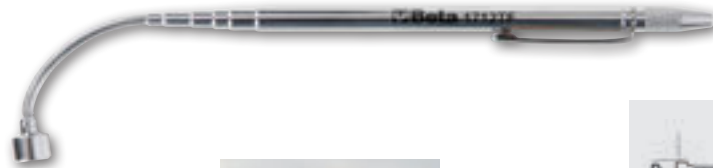



	L mm	D mm	F kg		
1712TF	150+590	11	1	61 g	017120600

## 1737NX

Brake shoe cleaning brush, steel wires

- Plastic handle





	L mm		
1737NX	270	144 g	017370010

## 1737

Brush with, brass wires



	L mm		
1737	145	20 g	017370001

**1751**

**Metal pressure oil cans**  
flexible spout

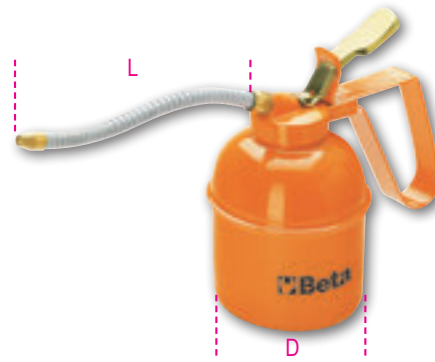

cc	D mm	L mm	g	
300	75	140	281	017510003
500	85	140	308	017510005

**1753**

**Plastic pressure oil cans**  
flexible spouts

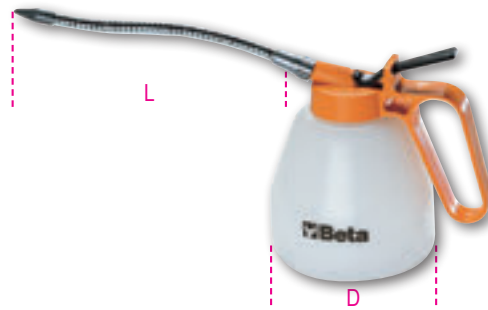

cc	D mm	L mm	g	
300	80	190	114	017530003
500	95	190	127	017530005

**1756B**

**Pen oiler**

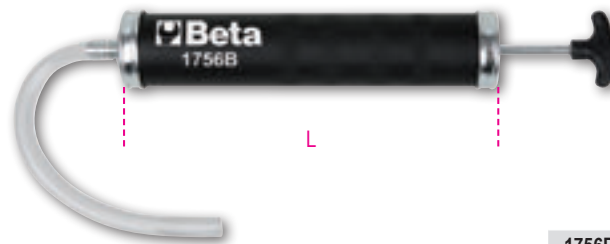

	cc	L mm	g	
1756B	500	190	820	017560220

**1756C**

**Suction gun, 200 ml**  
made of polypropylene

- Also suitable for braking system fluid
- Double EPDM gasket
- Operating temperature: +0 - +50 °C
- NOT suitable for fuel



	ml	L mm	g	
1756C	200	220	300	017560502

**1757**

**Battery fillers**



	cc	D mm	g	
1757	250	60	40	017570002

**1761**

Wire twisting pliers with automatic return

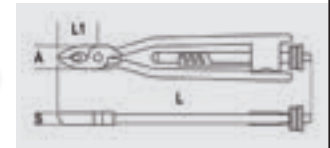

	L mm	L1 mm	A mm	S mm		
1761	255	40	21	11	300 g	017610101

**1761RS/1**

Reversible wire twisting pliers with automatic return

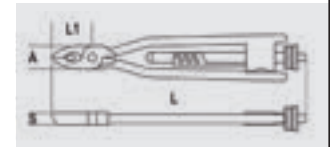

	L mm	L1 mm	A mm	S mm		
1761RS/1	220	30	15	10	250 g	017610130

**1767PMR**

Magnetic tool holder, rectangular



1767PMR	017670010
---------	-----------

**1767PMC**

Magnetic tool holder, round



	Ø mm	
1767PMC	150	017670020

**1838/1 1 LED**

Rechargeable inspection lamp with ultra-high brightness LEDs. Lithium polymer battery

- Compact body made of antislip rubber
- Easy-to-replace front glass
- Swinging hook
- With charging station, 110-230Vac
- 320 lumens
- With multidirectional head LED



IP65 CE 1838/1LED	334 g	018380111

## 1838SL

**Ultra-thin inspection lamp with ultra-high brightness LEDs.**  
For jobs in small areas

- Power supply: 12V, with lighter socket and battery terminals
- 2.5-m-long cable
- Thickness: 6 mm
- 345 lumens



CE 1838SL 6 mm 100 g 018380101

## 1838SLR

**Rechargeable, articulated LED inspection lamp**

- Compact front LED (200 lumens) and head LED (100 lumens) for inspections
- Lighting body no more than 9 mm thick
- operating range: 5/2.5 hours (depending on light level setting)
- With USB charger
- With metal hook and magnet



IP30 CE 1838SLR 204 g 018380201

## 1838SN

**Rechargeable, articulated LED inspection lamp**

- Articulated
- Non-slip rubber body
- Double swinging hook
- Magnets on base and back for increased adjustability
- With charger 100-240V / 50-60Hz
- Double light emission, front and head (spot)
- 250 lumens / spot 150 lumens
- Operating range: 3h / spot 3h
- With charge indicator



IP20 CE 1838SN 460 g 018380132

**1850B**

**Heat gun**

- Pos. 1 240 l/min. 300°C
- Pos. 2 450 l/min. 500°C



230V  
Schuko L=2,4 m

	L mm	H mm	W	°C	V	l/min		
1850B	240	190	1600	300-500	230	240/450	1 kg	018500011

**1851VK**

**Hot glue gun with 12 thermofusible glue sticks in case**

- Ø 11 e 12 mm
- Power: 80 watt



320x250x50 mm	CE	1851VK	600 g	018510058
---------------	----	--------	-------	-----------

**1879 6**

**Manual operation fluid extractor, 6 l**

- 3 hard pipes that can be connected to each other
- 1 hose specifically designed for brake oil bleeding



1879 6	3,7 kg	018790000
--------	--------	-----------

## 1880

### Manual barrel pump

- For nonaggressive oil and fluids
- Do not use with aqueous fluids, acid solvents, Diesel oil, petrol and the like
- Complete with barrel connection, telescopic tube and delivery spout



	gr		
<b>1880</b>	240	2,4 kg	018800001

## 446/C30

### Assortment of chrome-steel taps and dies, metric thread, and accessories in wooden case



370x230x55 mm

430 M mm	440 M mm		
3x0,5	3x0,5	435/1,5	444/1
4x0,7	4x0,7		
5x0,8	5x0,8		
6x1	6x1		
8x1,25	8x1,25		
10x1,5	10x1,5		
12x1,75	12x1,75		

<b>446/C30</b>	1,2 kg	004460055

## 1895

### Ultrasonic cleaning tank

- Ultrasonic cleaning relies on fluid heating to effectively clean spare parts and metal pieces in general (carburettors, valves etc.)
- Digital display for temperature and cleaning time selection
- Two cleaning modes: "soft" and "normal"
- For normal cleaning, just use water at a temperature of 50/60 °C
- For more accurate cleaning, add non-foaming detergent solutions specific for ultrasonic tanks
- Using the degas mode speeds up air release throughout the tank, thereby improving ultrasonic cleaning efficiency



	6 l	13 l	27 l
Tank capacity	6 l	13 l	27 l
Drain tap	✓	✓	✓
Power	150 Watt	300 Watt	500 Watt
Heating power	300 Watt	400 Watt	500 Watt
Temperature range	0÷80°C	0÷80°C	0÷80°C
Cleaning time range	0-99 min	0-99 min	0-99 min
Frequency	40 kHz	40 kHz	40 kHz
Power supply	220/230V	220/230V	220/230V
Dimensions	330x180x310 mm	350x325x320 mm	530x330x380 mm
Tank dimensions	300x155x150 mm	325x235x145 mm	500x300x200 mm

<b>1895 6</b>	6	8,1	018950060	
<b>1895 13</b>	13	12,5	018950130	
<b>1895 27</b>	27	13,5	018950270	

**1897**

**Professional bench sander**

- Particularly recommended for surface finishing jobs on several materials (metal, plastic, glass, ceramic, wood etc.). The cabin is made from properly reinforced sheet steel which results in unparalleled sturdiness and firmness.
- The cabin is equipped with the following:
  - Loading door with magnet closure
  - Perforated sheet metal top
  - Standard connection for vacuum cleaners,  $\varnothing$  36 mm
  - Protective polycarbonate viewing window, 6 mm
  - LED lamp
  - Pneumatic circuit (compressed air inlet)
  - Sanding gun with trigger operation



Useful dimensions of cabin	600x520x320 mm
Overall dimensions	660x530x500 mm
Worktop	Perforated sheet metal
Lighting	LED
Air consumption	340 l/min a 7 atm
Power supply	220 V - 50 Hz



CE 1897 38 kg 018970066

**1897/KSA**

**Bench sander item 1897, complete with vacuum cleaner item 1871M/AS**

- Automatic filter cleaning
- Two-stage by-pass motor
- Voltage: 230/240 V
- Max. power: 1200 W
- Max. service outlet power: 2000 W
- Max. pneumatic tool connection pressure: 15 bar
- Airflow rate: 60 l/sec.
- Max. suction power: 220 mbar
- Max. drum capacity: 35 l, made of antistatic PE-HD
- Acoustic emissions: <68 dB(A)
- Cable length: 7 m



1897/KSA 49 kg 018970660

**1897/CRB**

**Corundum**  
For sander 1897  
in 25 kg bag



1897/CRB 25 kg 018970101

**1897/MV**

**Glass microspheres**  
For sander 1897  
in 25 kg bag



1897/MV 25 kg 018970103

**1897/G**

**Garnet**  
For sander 1897  
in 25 kg bag



1897/G 25 kg 018970104



## 3027 10

### Hydraulic bench press with moving piston

- Maximum capacity: 10 t
- Manual 2-speed pump
- Moving piston
- Chrome-plated stand
- Automatic piston return
- Gauge
- Set of V-shaped prisms included



3027 10	L mm	H mm	90 kg	030270010
---------	---------	---------	-------	-----------

## 3027 20

### Hydraulic press with moving piston

- Maximum capacity: 20 t
- Manual 2-speed pump
- Moving piston
- Chrome-plated stand
- Automatic piston return
- Hydraulic safety in case of overloading
- Gauge
- Set of V-shaped prisms included



3027 20	L mm	H mm	140 kg	030270020
---------	---------	---------	--------	-----------



“Photo Milagro”

## 600/1

### Torque angle indicators

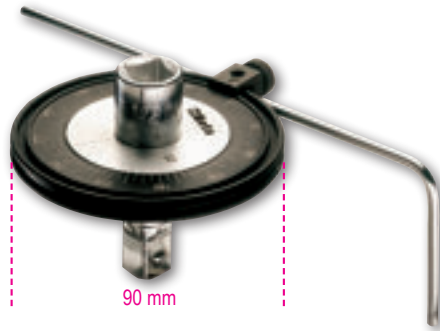

600/1 1/2 1/2 548 g 006000001

## 601C

### Digital angle indicator, magnetic

- For tightening screws to values set by measuring torsion angle
- Complete with buzzer and LED indicators informing user that preset angle has almost or finally been reached
- For right-hand and left-hand tightening
- Angle accuracy: +/-2%
- Resolution: 0.1°
- Up to 9 angle values can be preset
- Up to 50 measurements can be preset
- Supplied in an ABS case
- Power supply: 2 AAA-size batteries (included)



CE 601C 70 g 006010100

## 665

### Mechanical torque wrench with digital readout, suitable for right-hand tightening, torque accuracy ± 3%

- Easy-to-read measurements
- Display will remain on with set torque value
- Torque setting to decimal digit
- Auto power off after 10" when torque is set under minimum torque threshold
- Power supply: battery 1 3V (included)

	Nm	■	D mm	A mm	L mm	g	📄
665/6	10÷60	3/8	30	33	335	655	006650006
665/10	20÷100	3/8	30	33	375	725	006650010
665/10X	20÷100	1/2	30	37	375	725	006650011
665/20	40÷200	1/2	40	43	470	995	006650020
665/30	60÷300	1/2	40	43	590	1260	006650030





## Click-type torque wrenches with reversible ratchets, torque accuracy $\pm 3\%$

- Scale increased by 60% for improved visibility and setting accuracy
- Torque adjusting speed increased by 40%
- Handle and lens materials resistant to all chemical substances used in automotive sector, industry and aviation
- Red colour of o-ring indicates that wrench is unlocked and torque can be adjusted
- When not in use, set torque to lowest value of torque wrench range

### 666N

For right-hand tightening

UNI EN 26789 ISO 6789

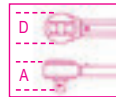

	Nm	Kgfm	lbf.in	■	D mm	A mm	L mm	g	
666N/2	5÷25	0,5÷2,5	4÷18	1/4	25	29	215	300	006660002
666N/5	10÷50	1÷5	7÷37	3/8	30	33	312	660	006660005
666N/10	20÷100	2÷10	15÷75	3/8	30	33	381	730	006660010
666N/20	40÷200	4÷20	30÷150	1/2	40	43	470	1010	006660020
666N/30	60÷300	6÷30	50÷220	1/2	40	43	598	1380	006660030

### 667N/30

For right-hand and left-hand tightening

UNI EN 26789 ISO 6789

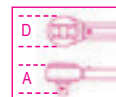

	Nm	Kgfm	lbf.in	■	D mm	A mm	L mm	g	
667N/30	60÷300	6÷30	50÷220	1/2	40	43	598	1380	006670030

### 665SW

Calibration device

- Device allows calibration of wrenches item 665 with help of torque meters 680 and 682, without having to dismantle wrench.
- Calibration is performed on several points, to compensate for nonlinear behaviour of spring.
- Fitted with a micro USB port, for firmware updates.



665SW 40 g 006650100

## 960P

**Pressure/depressure tester**  
with accessories and adaptors



370x230x55 mm

960P

1,9 kg

009600777

## 1760PA/80

**AC/DC amperometric clamp, 80A**  
Specifically designed to measure  
low current leakage or absorption  
values on vehicles

- Range: 1mA-80A AC/DC
- Torch function with white LED
- Backlit LCD display
- Zero setting function
- Hold function
- Auto power off
- Power supply: 2 1.5V AAA-type batteries



CE

1760PA/80

270 g

017600002

## 1760B

**Digital multimeter**

**SPECIFICATIONS**

DC voltage: 200 mV-2/20/200/1000V

AC voltage: 2-20/200/700V

DC current: 2/20/200 mA-20 A

AC current: 2/200 mA- 20 A

Resistance: 200Ω - 2/20/200 kΩ - 2/20 MΩ

Capacity: 2/20/200 nF - 2/200 μF

Temperature: -20° + 1000°C/ -4 °F ~ +2000°F

Frequency: 20kHz

Power supply: 1 9V battery (included)



CE

1760B

670 g

017600012

## 1760/TC2

### Combination contact/non-contact digital tachometer

#### TECHNICAL DATA

- For measuring:
  - non-contact rotational speed (rpm)
  - contact rotational (rpm) and linear surface speed (m/min or ft/min).
- 5-digit LCD display.
- Scale:
  - non-contact speed 2.5 ÷ 99,999 rpm
  - contact speed 0.5 ÷ 19,999 rpm
  - linear surface speed 0.05 ÷ 1,999.9 m/min.
- Frequency: 0.8 sec.
- Power supply: 4 1.5V batteries, AA size, or 6V power supply unit (not included).



Supplied with the following:

- Adaptor for contact tip measurement;
- Male (contact) rubber tip (2 pcs.);
- Female (contact) rubber tip (1 pcs.);
- Linear measurement tape (1 pcs.);
- Reflecting tapes;
- Instruction manual;
- Plastic case.

CE	1760/TC2	L	H		
		mm	mm		

## 1760/IR500

### Digital infrared thermometer with dual laser aiming system

#### TECHNICAL DATA

- Temperature range: -50 ÷ 500 °C (-22 a 932 °F)
- Display resolution: 0,1 °C (0,1 °F)
- Emissivity: regolabile 0,1 ÷ 1
- Accuracy: -50 a 20°C (+/- 3°C);  
20 ÷ 500°C (+/-2% o 2°C)
- Optical resolution (D:S): 12:1
- Auto power off: circa 10 secondi
- Operating temperature: 0 ÷ 50°C
- Storage temperature: -20 ÷ 60°C
- Power supply: 1 battery 9 V



CE	1760/IR500		
		350 g	017600350





**955**

Tubular spark-plug wrench  
chrome-plated, hexagon end

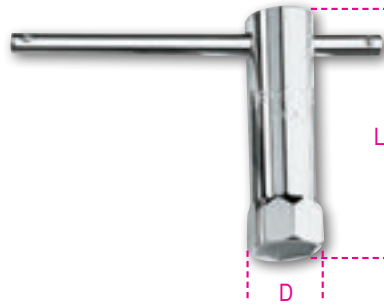

mm -"	D mm	L mm	g	
16	21	86	140	009550016
5/8				
20,8	29	86	190	009550021
13/16				



**956C**

1/2" square drive spark  
plug sockets chrome-plated,  
hexagon ends

ISO 11168



mm -"	Ø mm	L mm	g	
14				
9/16	18,8	70	95	009560008
16				
5/8	21,4	70	105	009560010
17,8				
11/16	23,6	70	140	009560011
20,8				
13/16	27,0	70	160	009560012



**956L**

1/2" square drive spark  
plug sockets, bi-hex ends,  
long series

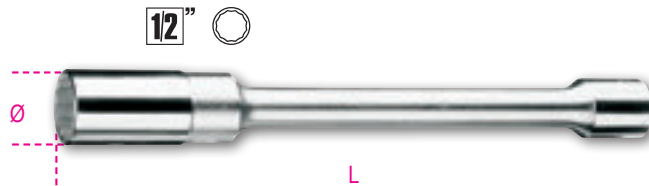

mm -"	Ø mm	L mm	g		mm -"	Ø mm	L mm	g	
14					17,8				
9/16	20,2	250	370	009560214	11/16	24,0	250	430	009560217
16					20,8				
5/8	24,0	250	375	009560216	13/16	28,5	250	430	009560221



**957**

T-handle spark plug wrenches  
with swivelling sockets

ISO 11168

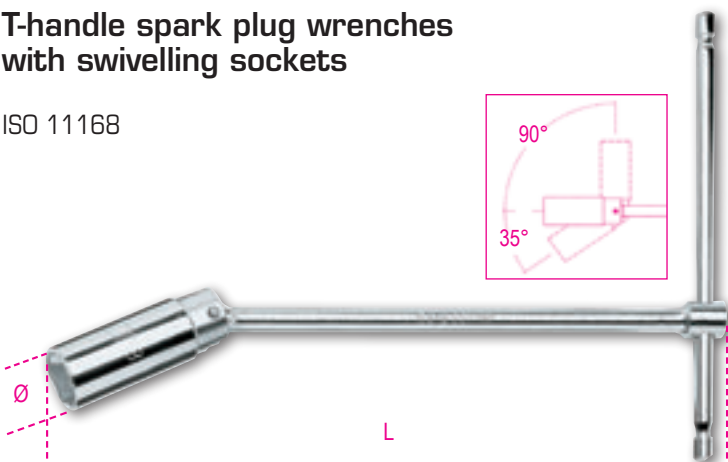

mm -"	Ø mm	L mm	g	
16				
5/8	21,4	275	300	009570000
20,8				
13/16	27,0	275	340	009570001



**1440**

Piston ring compressors



	Ø mm	D mm	g	
1440/0	40÷75	50	140	014400000
1440/1	57÷125	80	250	014400010
1440/1A	57÷125	100	300	014400011

**1445/1**

Piston ring expanders



1445/1	∅ mm 50+100	200 g	014450001

**1450GC**

Valve spring compressor with straight and offset jaws

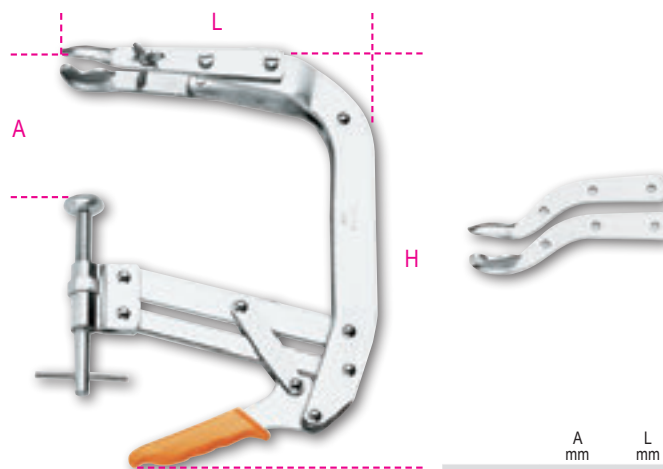

	A	L	H		
1450GC	45+225 mm	205 mm	300 mm	1,6 kg	014500005

**1474L**

Spark-plug pliers, curved long nose, 15°

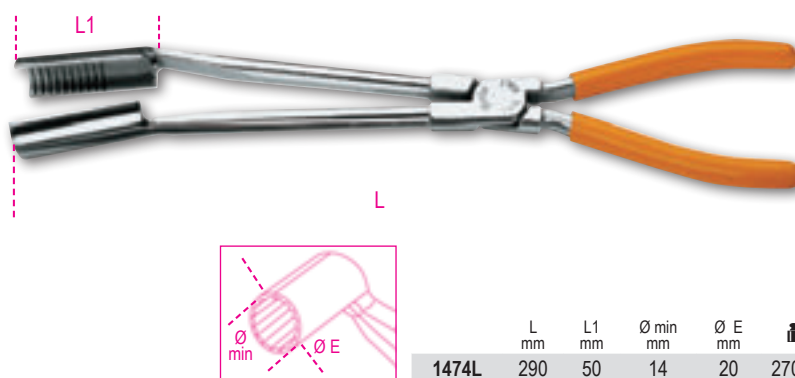

	L	L1	∅ min	∅ E		
1474L	290 mm	50 mm	14 mm	20 mm	270 g	014740010

**1474DL**

Spark-plug pliers, long nose, double layer PVC coated handles



	L	L1	∅		
1474DL	275 mm	170 mm	12 mm	310 g	014740015

**1708/8**

**Metric feeler gauges**

- Steel blades with rounded ends.
- Locking screw.
- Thicknesses in mm/inches.



	S mm	S "	L mm		
1708/8	0,05+0,50	0,002+0,020	105	35 g	017080008

**1439/K7**

**Angular screwdriver (90°), long series, with blades**

Case contents:

- Angular screwdriver
- 1 slotted screw head
- 1 1/4" bit head
- Special blade head
- 7 special blades

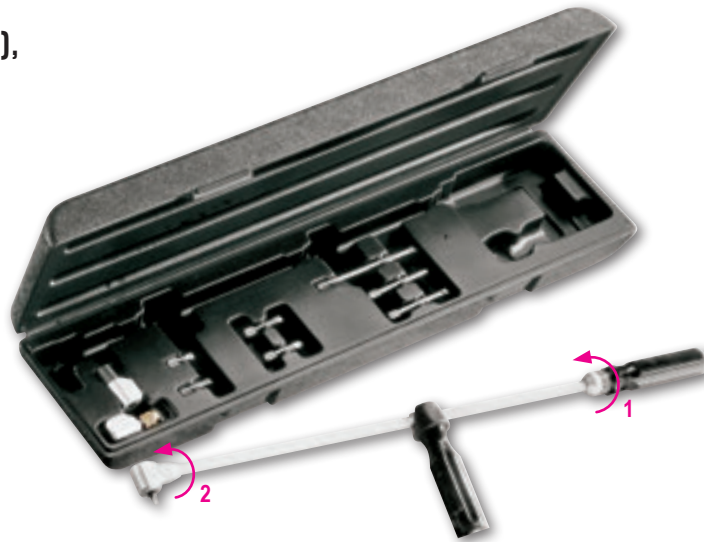

	500x120x60 mm	1439/K7	1 kg	014390101
--	---------------	---------	------	-----------

**1410/M**

**Spring pulling hook wrench**



	L mm	Ø mm		
1410/M	155	3,5	50 g	014100051

**1490/1**

**Strap wrenches for oil filters**

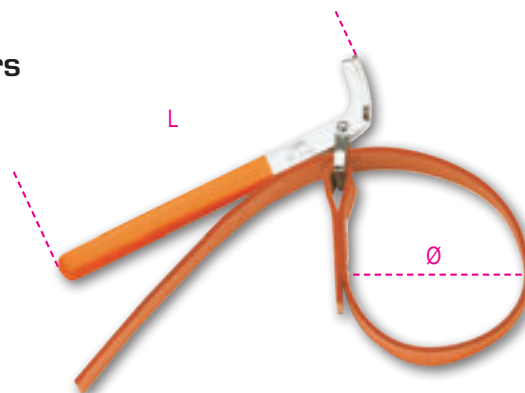

	Ø max mm	L mm		
1490/1	160	225	290 g	014900001



**1493H**

Self-adjusting oil filter wrench with 3 arms, for right and left hand tightening

38" 12"

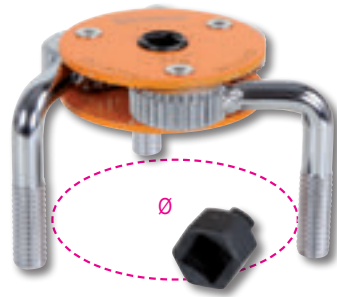

	Ø mm	g	
1493H	72÷127	550 g	014930077

**1493/X**

Self-locking oil filter wrenches, right-hand

38"



	Ø mm	g	
1493/X1	60÷80	410	014930105
1493/X2	80÷98	710	014930110

**1493**

Oil filter wrench

12"



Ø mm	N	g		Ø mm	N	g		Ø mm	N	g				
1493 65-L14	65	14	120	014930200	1493 76-L14	76	14	170	014930218	1493 92-L10	92	10	192	014930236
1493 68-L14	68	14	140	014930206	1493 76-L15	76-74	15	183	014930220	1493 93-L15	93	15	209	014930238
1493 73-L14	73	14	151	014930208	1493 78-L15	78	15	161	014930224	1493 95-L15	95	15	198	014930244
1493 74-L14	74	14	142	014930209	1493 80-L15	80	15	163	014930226	1493 100-L15	100	15	253	014930248
1493 74-L15	74	15	151	014930210	1493 82-L15	82-80	15	192	014930228	1493 106-L15	106	15	245	014930250
1493 75/77-L15	75-77	15	161	014930212	1493 86-L16	86	16	234	014930230	1493 108-L15	108	15	247	014930252
1493 76-L8	76	8	147	014930214	1493 90-L15	90	15	204	014930234	1493 135-L18	135	18	571	014930256

**1878 11**

Fluid collection tank

- Maximum capacity: 11 l
- Fluid drain plug
- Interior wall for preventing fluid leakage during transportation



	g	
1878 11	850 g	018780011

## CB52

### Gearbox/transmission trolley with liquid recovery system

Inclined plane and drain holes allow liquids to be recovered in collection tank:

- 4 swivel castors, including 2 with brakes
- Tool drawer
- Pull-out liquid collection tank; capacity: 7 l
- 2 shelves

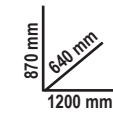

**CB52-O**  60 kg  052000201

## Electric system

### 1498/2A

### Electronic motorcycle battery charger, 12V

Allows charging of all Pb Wet, Agm, Gel, Mf and Vrla battery types and LiFePo4 lithium batteries

- Two different types of charge, for lithium and lead acid batteries respectively
- Automatic multi-stage charge cycle
- Reverse polarity and short-circuit protection
- IP65 degree of protection
- Complete with cable with clamps and cable with eyelets
- Power supply voltage: 220-240V





#### TECHNICAL DATA

- Charging current: 1A
- Charging capacity: 2Ah-40Ah
- Frequency: 50-60 Hz
- Battery voltage: 12V
- Dimensions: 180x80x40 mm



IP65



1498/2A  500 g  014980102

**1498/4A**
**Electronic car/motorcycle battery charger, 6-12 V**

- Protected against polarity reversal and short circuits
- Automatic 6 V or 12 V selection
- Automatic battery type selection
- Digital backlit display
- Pull-back fixing hook
- Complete with cable with clamps and cable with eyelets

**TECHNICAL DATA**

- Power supply voltage: 220V-240V
- Frequency: 50-60 Hz
- Rated current (min-max): 1-4 Amp
- Battery voltage: 6V/12V
- Battery capacity: 4Ah-80Ah
- Charging time: 12 hours
- Degree of protection: IP65

**1498CM/12**
**Portable motorcycle emergency starter**

3 functions in 1:

- Starter
- Additional battery for electronic devices (tablets, smartphones etc.)
- High-brightness LED torch

Equipment:

- Starting cable with insulated clamps and protection diode
- Mains battery charger
- Car battery charger
- USB cable with charge adapters

**TECHNICAL DATA**

- Starting current: 200A
- Peak current: 400A
- USB outlet: 5V 2,1A
- Dimensions: 130x50x15 mm



**3080/C15**

**Chain opening and riveting kit**

Ø 3-4-5 + Regina kit

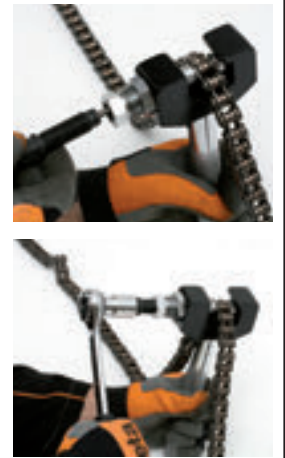

420x185x60 mm 3080/C15 2 kg 030800015

**3081**

**Portable chain tool**

Sturdy and foldable, easily fitting into enduro tool bags.

Suitable for chain sizes 415, 420, 428, 520, 525, 530



3081 L mm 124 282 g 030810010

**1467**

**Brake fluid extractor**

Pressure: min 5 bar, Max 11,5 bar



1467 1,5 1,5 kg 014670001

**3085**

**Tool for retracting brake pistons**

Suitable for motorcycle and scooter brake callipers

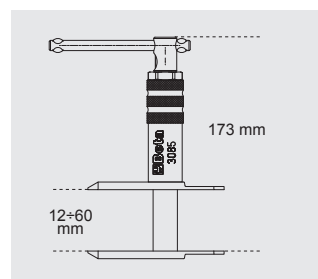

3085 694 g 030850010

**3073**

**Universal fork oil seal driver fitting tool**

For fork tube diameters 43 a 48 mm

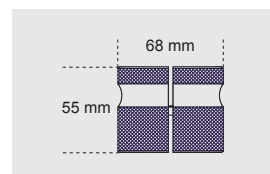

3073 221 g 030730001





## 962

### Tyre levers



L mm	A mm	g	Icon	L mm	A mm	g	Icon
300	21	300		500	27	750	
400	25	450		600	27	1000	



## 986 48

### Tyre valve screwdriver, short model

- Automatic valve retention
- Particularly suitable for small diameter tyres, e.g. scooter tyres

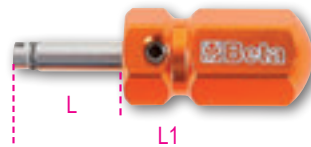

Model	L mm	L1 mm	g	Icon
986 48	18	48	16 g	



## 986 78

### Tyre valve screwdriver

- Automatic valve retention



Model	L mm	L1 mm	g	Icon
986 78	18	78	32 g	



## 1949DGT

### Digital tyre inflator

- Operating pressure: 0÷11 bar (2.0÷160 psi)
- 4 units of measurement: psi/bar/kgcm<sup>2</sup>/kpa
- Backlit LCD display
- Reset feature
- Self-power off after 3 min.
- Pressure release button
- Resolution: 0.05 bars
- ABS housing, protective rubber shell on gauge, shockproof, nonslip handle grip
- Power supply: 2 AAA size 1.5V batteries
- Compatible with coupling 1916G 1/4"

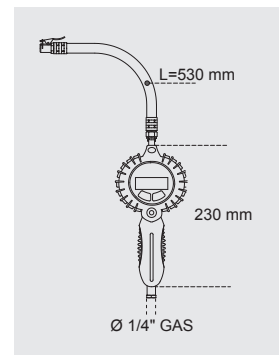

Model	bar	g	Icon
CE 1949DGT	0÷11	500 g	

**1949GPE**
**Tyre inflator**

- Operating pressure: 0÷11 bars (10÷160 psi)
- Pressure release feature
- Pressure measurement feature
- Gauge coated with shockproof rubber
- 360 degree hose rotation

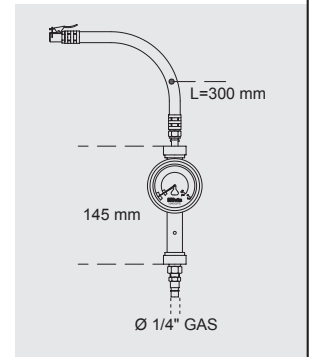

	bar		
1949GPE	0÷11	640 g	019490008

**1949M**
**Tyre pressure tester**

- Reading pressure: 0÷4 bars (5÷60 psi)
- Accuracy: 0.1 bars (1.0 psi)
- Pressure measurement feature
- Pressure release feature
- Gauge coated with shockproof rubber
- Hose length: 350 mm



	bar		
1949M	0÷4	280 g	019490400

**1949T**
**Telescopic progressive blow gun**

- Hard-wearing, shockproof composite material body
- Telescopic steel swivel tube: 165 mm ÷ 300 mm

**TECHNICAL DATA**

- Aluminium threaded insert: 1/4" GAS
- Operating pressure: 6÷8 bar
- Maximum operating pressure: 15 bar
- Mean air consumption: 144 l/min
- Operating temperature: -20°C ÷ 70°C

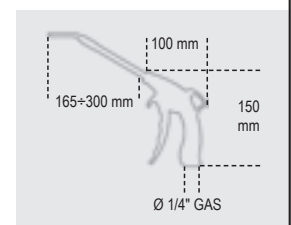



1949T	190 g	019490040

## 3070B

### Manual static balancer

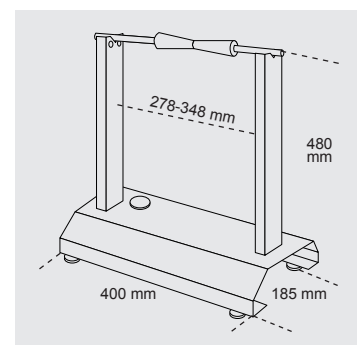
- Allows wheel balancing both in the workshop and on racing tracks
- Equipped with rolling bearings, rabbet level and adjustable feet for unparalleled precision
- Comes with 2 hub cones



**3070B**  11,4 kg  030700100

## 3075/K10

Set with a universal wrench with interchangeable head and 10 bits, for tightening wheel spokes



 133x103x30 mm **3075/K10**  231 g  030750410



### 3075A

Hexagon socket  
for wheel hub nuts

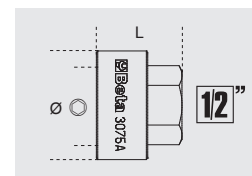

mm	Ø mm	L mm	g	
28	38	30	47	030750028
30	40	30	49	030750030

### 3075B

Bi-hex socket  
for wheel hub nuts  
Ducati

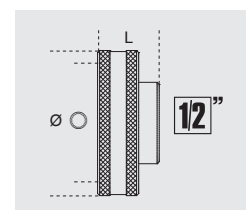

	mm	Ø mm	L mm	g	
3075B	55	70,7	25	155	030750155

### 3075MV

Bi-hex socket  
for wheel hub nuts  
MV AGUSTA

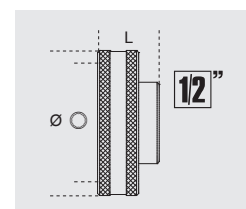

	mm	Ø mm	L mm	g	
3075MV	56	70,7	25	155	030750156

### 3075/CM

Multiple hexagon socket  
for wheel pins

Sizes: 12-14-17-19-22-24 mm

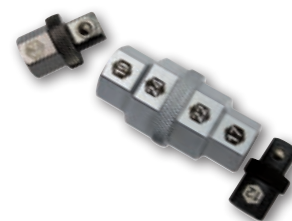

	g	
3075/CM	34	030750212

## 3040C

### Rear motorcycle stand, adjustable

- Includes V-shaped sliders, pair
- Includes L-shaped sliders, pair



4 thermoplastic rubber wheels

3040C 5,2 kg 030400002

## 3042C

### Front stand for motorcycle steering pin

- Matt black lacquer
- 4 thermoplastic rubber wheels
- Includes 8-pin kit Ø 13 - 15 - 15.5 - 17 - 19 - 20 - 21 - 27



3042C 8 kg 030420002



### 3041C

#### Front motorcycle stand, adjustable

- Includes roller sliders, pair
- Includes cone-shaped sliders, pair



3041C 3,8 kg 030410002

### 3043C

#### Motorcycle stand with left single arm

- Matt black lacquer
- 4 thermoplastic rubber wheels



3043C 5 kg 030430002

### 3043C/...

#### Pin for item 3043C



		Ø mm	g	
3043C/41	Ducati	21,5 / 25,5	500	030430551
3043C/42	Triumph	27,5	500	030430552
3043C/43	MV	42,5	500	030430553
3043C/44	Ducati	40,5	500	030430554
3043C/45	Honda	28,5	500	030430555
3043C/47	BMW	53,5	500	030430557

## 3047C

### Pedal stand for cross/enduro motorcycles

Technical specifications:

- Minimum height: 310 mm
- Maximum height: 390 mm
- Support: 260x170 mm
- Capacity: 136 kg



3047C 6,3 kg 030470002

## 3048C

### Aluminium racing cross stand

Dimensions:

- Height: 400 mm
- Support: 250x250 mm
- Capacity: 150 kg



3048C 4,7 kg 030480002

## 3050/CC

### Chock cradle centre stand for Custom, Enduro, Cross, Scooter motorcycles

includes adjustable support kit

Technical specifications:

- Minimum height: 90 mm
- Maximum height: 405 mm
- Capacity: 350 kg
- Lifting height: 315 mm
- Column height: 130 mm
- Overall dimensions: 480x150 mm

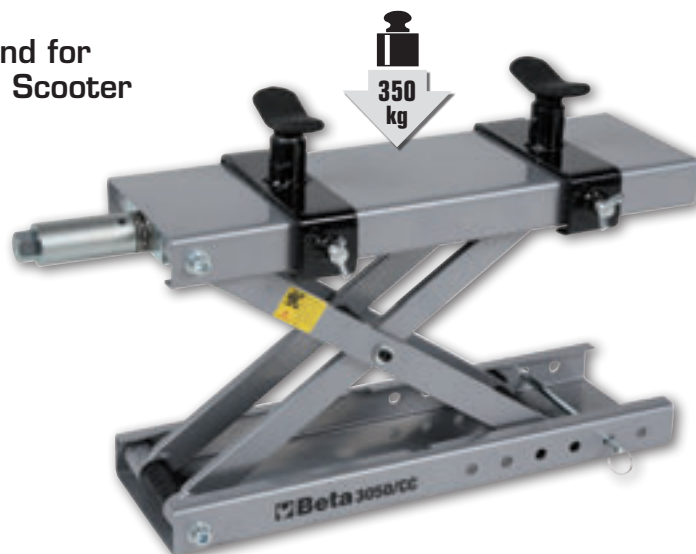

3050/CC 15 kg 030500012

 3054**Moving base for central stand or  
motorcycle rear wheel  
with extension for side stand**

- For use with all motorcycles and scooters with central stands
- With 4 swivel castors, 2 with brakes
- Allows motorcycles to be moved in all directions, thereby making it easier to park them in small areas



   
3054 15 kg 030540000



## 3050/600

### Electro-hydraulic motorcycle jack 600 kg

Technical specifications:

- Electrical, mechanical and hydraulic safety devices
- Capacity: 600 kg
- Integrated electro-hydraulic unit: 230V - 50 Hz
- Hydraulic pump
- Controlled downward speed
- Safety fuses for protection in case of cable cuts
- control push button panel
- CE-certified, TÜV-approved

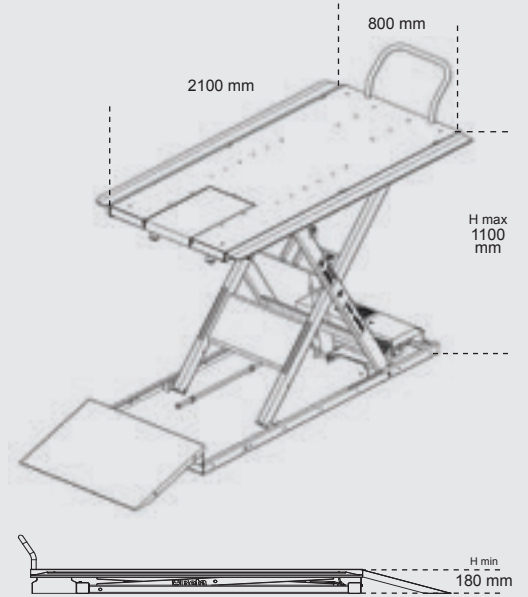

	Weight	Accessories
3050/O	200 kg	030500201
3050/G	200 kg	030500202
3050/R	200 kg	030500203

## 3050/KA

### Widening kit for jack item 3050/600



	Weight	Accessories
3050/KA-O	60 kg	030500221
3050/KA-G	60 kg	030500222
3050/KA-R	60 kg	030500223



Run-up ramp



Front safety bar



Gate



Side tools holders



**9562T3**

pag 12

**3050/MS**

Wheel clamp for jack item 3050/600



**3050/MS** 15 kg 030500032

**3050/LA**

Non-slip sheet metal top for jack item 3050/600

Dimensions: 540x340 mm

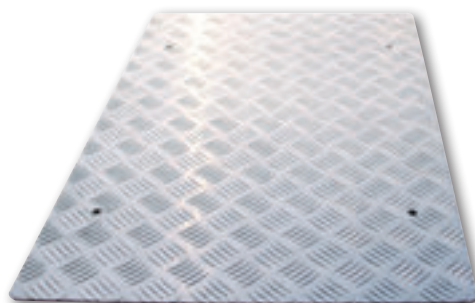

**3050/LA** 1,6 kg 030500062

## 3055M

### Automatic van clamp

Allows motorcycle front wheel to be fixed



3055M 11 kg 030550002



## 3057

### Aluminium ramp for loading/unloading motorcycles

Technical specifications

- Dimensions: 1820x300 mm
- Capacity: 200 Kg



3057 7 kg 030570001

## 3079/21

### Cable oiler

Allows proper lubrication of clutch cables and gas control, for increased sheath smoothness and cable duration.



3079/21 40 g 030790021



### 3091

Flywheel pullers  
with internal thread



	M	
3091/10	24x1,5	030910010
3091/20	26x1,0	030910020
3091/30	28x1,0	030910030
3091/40	30x1,0	030910040
3091/45	30x1,5	030910045
3091/50	32x1,5	030910050
3091/60	33x1,5	030910060
3091/70	35x1,0	030910070
3091/75	35x1,5	030910075
3091/80	38x1,5	030910080

### 3092

Flywheel pullers  
with external thread



	M	
3092/10	18x1,5	030920010
3092/20	19x1,0	030920020
3092/30	27x1,25	030920030
3092/35	22-26x1,5	030920035
3092/40	25x1,5	030920040
3092/50	26-28x1,0	030920050
3092/60	28x1,5	030920060

### 3093/E

Tool for locking flywheel,  
clutch bell and pulleys



3093/E	1 kg	030930100
--------	------	-----------

### 3093/U

Multiple flywheel puller

Sizes  
M10x1.25R  
M14x1.5R  
M16x1.5R  
M18x1.5R  
M24x1.0R  
M27x1.0L



3093/U	700 g	030930050
--------	-------	-----------

## 8188F

Cam buckle straps,  
LC 200 kg, high-grade  
polypropylene (PP) belt

EN 12195-2



	L m	g	
8188F 1,5	1,5	56	081880215
8188F 2,5	2,5	72	081880225
8188F 5	5	110	081880250

## 8188C

Ring ratchet tie downs,  
LC 750 kg, high-tenacity  
polyester (PES) belt

EN 12195-2

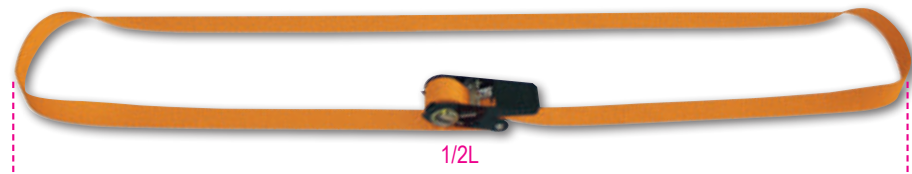

	L m	g	
8188C	5	323 g	081880350

## 8188CG/25

Ratchet tie downs with  
S-hooks and Eyes,  
LC 375 kg high-tenacity  
polyester (PES) strap

EN 12195-2

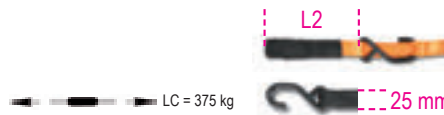
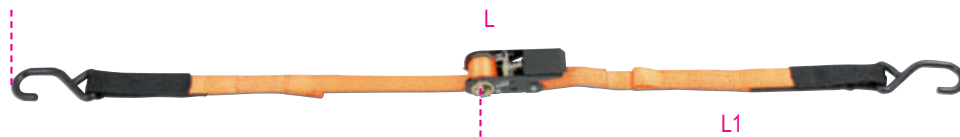

	L m	L1 mm	L2 mm	g	
8188CG/25 3	3	480	170	475	081880430
8188CG/25 5	5	480	170	519	081880450

## 8188FG2

Cam buckle straps with  
2 S-hooks and Eyes,  
LC 250 kg high-grade  
polypropylene (PP) belt

EN 12195-2

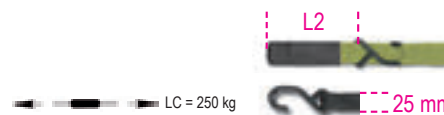

	L m	L1 mm	L2 mm	g	
8188VFG2 3	3	450	110	418 g	081881530

## 8130A

**Anti-theft chains with rings, made of alloy steel, case-hardened, tempered, galvanised**

- Alloy steel, hardened and tempered to counteract the manual sawing.
- High-quality electroplating.
- Covered with textile tube: it minimizes the encumbrance and prevents scratches.

### AVAILABLE CERTIFICATES

- Test report UNI EN10204 type 2.2

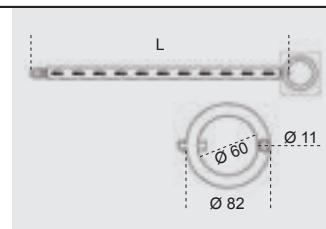

	Ø mm	L mm	kg	
8130A	10	900	1,9	081300209

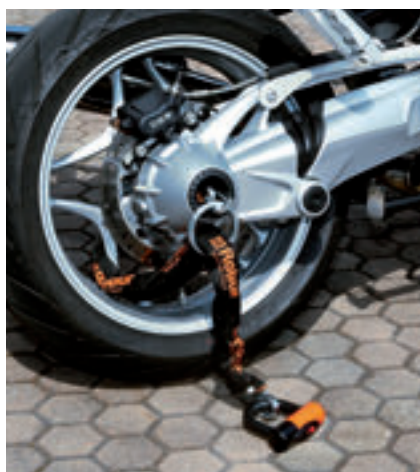

## 8139DL

**Motorcycle disc locks, made of hardened steel, shockproof PVC, blister-packed**

- 14 mm alloy steel locking shackle, hardened and tempered, covered with scratch-resistant pvc sheath
- Cut resistant, impact resistant, weather resistant
- Protective cap for the lock
- For chain links 10 mm (min.).
- Suitable for 10mm chains

### AVAILABLE CERTIFICATES

- Test report UNI EN10204 type 2.2

Included in the package:

- Transport bag
- 3 keys
- High visibility lock-reminder cord

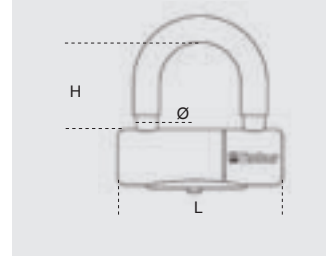

	Ø mm	L mm	H mm	g	
8139DL	14	108	56	600	081390214

## 8130

**Antitheft chains made of alloy steel, case-hardened, tempered, galvanised**

- Alloy steel with "D" shape links, hardened 57-60 HRC to counteract the manual sawing.
- High-quality electroplating
- Covered with textile tube: it minimizes the encumbrance end prevents scratches.

AVAILABLE CERTIFICATES

- Test report UNI EN10204 type 2.2

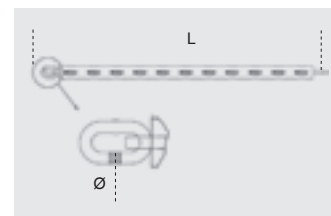

	Ø mm	L mm	kg	
8130 6X800	6	800	0,58	081300068
8130 8X1000	8	1000	1,47	081300081
8130 8X1200	8	1200	1,67	081300082
8130 10X1500	10	1500	3,15	081300105

## 8139Z

**Padlocks for antitheft chains, zinc alloy bodies**

- Corrosion resistant
- 10mm double locking shackle
- Safety punched keys
- Cut resistant / impact resistant
- Suitable for chains 6 e 8 mm

AVAILABLE CERTIFICATES

- Test report UNI EN10204 type 2.2

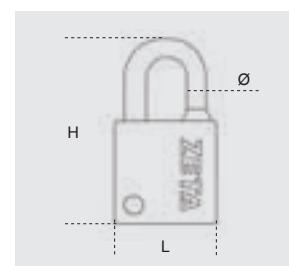

	Ø mm	L mm	H mm	kg	
8139Z	10	55	98	400 g	081390009

## 8139ZCH

**N°3 blank spare keys, item 8139Z**

- Duplicable by punching machine



	N°	
8139ZCH 3	x3	081390909
8139ZCH 9	x9	081390915
8139ZCH 10	x10	081390916

Art.					
31/B6	24	1490/1	40	2200-COVER C22S	4
99SQ	24	1493	41	2250-0	11
437C	24	1493H	41	2300-COVER C23S	4
437U/09	24	1493X/1	41	2400-COVER C24S	5
446/C30	31	1493X/2	41	3002	11
600/1	34	1498/2A	42	3027 10	33
601C	34	1498/4A	43	3027 20	33
665/...	34	1498CM/12	43	3040C	50
665SW	35	1500N/...	23	3041C	51
666N/2	35	1535/C...	23	3042C	50
666N/...	35	1545/C5M	23	3043C	51
667N/30	35	1599G	25	3043C/...	51
860/C27	20	1599P	25	3047C	52
900/C12MR	21	1708/8	40	3048C	52
900/C39	21	1712E/...	26	3050/CC	52
910A/C16HR	21	1712E/L1	26	3050/600	54
920A/C17MR	21	1712TF	26	3050/KA	54
941	22	1737	26	3050/LA	55
943FL	22	1737NX	26	3050/MS	55
950	19	1751	27	3054	53
950/S9	19	1753	27	3055M	56
950/S14	19	1756B	27	3057	56
951	19	1756C	27	3070B	48
951/S8	19	1757 250	27	3073	45
951/S14	19	1760/IR500	37	3075/CM	49
951TX	20	1760/TC2	37	3075/K10	48
951TX/S6	20	1760B	36	3075A 28	49
951TX/S13	20	1760PA/80	36	3075A 30	49
955	38	1761	28	3075B 55	49
956C	38	1761RS/1	28	3075MV 56	49
956L	38	1767PMC	28	3079/21	56
957	38	1767PMR	28	3080/C15	44
960P	36	1838/11LED	28	3081	44
962	46	1838SL	29	3085	45
986 48	46	1838SLR	29	3091/...	57
986 78	46	1838SN	29	3092/...	57
1254	25	1850B	30	3093/E	57
1281BG/A9	18	1851VK	30	3093/U	57
1281BG/B28A	18	1878 11	41	4100-COVER C41H	5
1281BG-TX/A8	18	1879 6	30	5904VG/2M	13
1295/C14	25	1880	31	5940SBK	14
1410M	40	1895 6	31	8130	60
1430/S5	23	1895 13	31	8130A	59
1433/C11	22	1895 27	31	8139DL	59
1439K7	40	1897	32	8139Z	60
1440/...	38	1897/CRB	32	8139ZCH	60
1445/1	39	1897/G	32	8188C	58
1450GC	39	1897/KSA	32	8188CG25	58
1467	44	1897/MV	32	8188F	58
1474DL	39	1949DGT	46	8188FG2	58
1474L	39	1949GPE	47	9562P2	12
1481PL/S3	25	1949M	47	9562P25	12
		1949T	47	9562T2	12
				9562T3	12
				C5	11
				C22S	4
				C23SC	4
				C23S	4
				C24S/5	5
				C24S/7	5
				C27S	7
				C39MD	8
				C39SM	8
				C41H	6
				C43	6
				C45/AW	10
				C45/AX	10
				C45/CW	10
				C45/CX	10
				C51	7
				C55AB	9
				C55PB/3	9
				C56	7
				CB52	42
				M15	15
				M25	15
				M31	15
				M33	15
				M46	15
				M50	15
				M55	15
				M62	16
				M65	16
				M69	16
				M83	16
				M85	16
				M86	16
				M91	16
				M92	16
				M105	16
				M125	16
				M130	17
				M131	17
				M145	17
				M153	17
				M204	17
				M208	17
				M210	17
				M230	17
				M234	17
				MC10	15
				MC11	15
				MC20	15
				MC21	15

# Beta MODULAR SYSTEM

## REC 55 SYSTEM



MADE IN ITALY





# Imagine and create...

Configure your workshop  
in 3D online



[www.rsc55.com](http://www.rsc55.com)

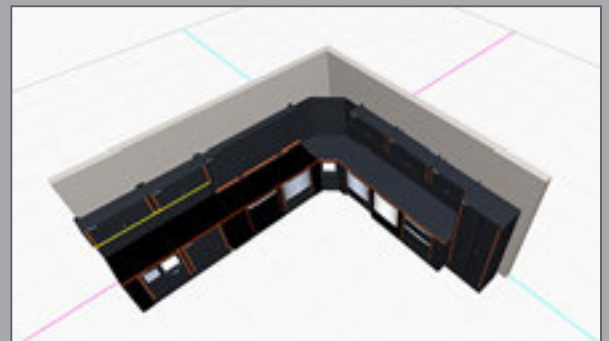



# Beta

Beta Utensili S.p.A.  
Via A. Volta 18  
20845 Sovico (MB)  
Tel.039.20771  
[www.beta-tools.com](http://www.beta-tools.com)

Jorge Navarro  
Moto2 World Championship



Technical Partner

